

APRIL 1977

BME

BROADCAST MANAGEMENT/ENGINEERING

**Move Over Quad... Era Of One-Inch Professional VTRs Begins.
Also: Radio & TV Programming Features Continued**



WLV 19657922-XM-4752 -AV1 -
Lynchajro
V6 24504

Of course they didn't leave time for post-production editing.

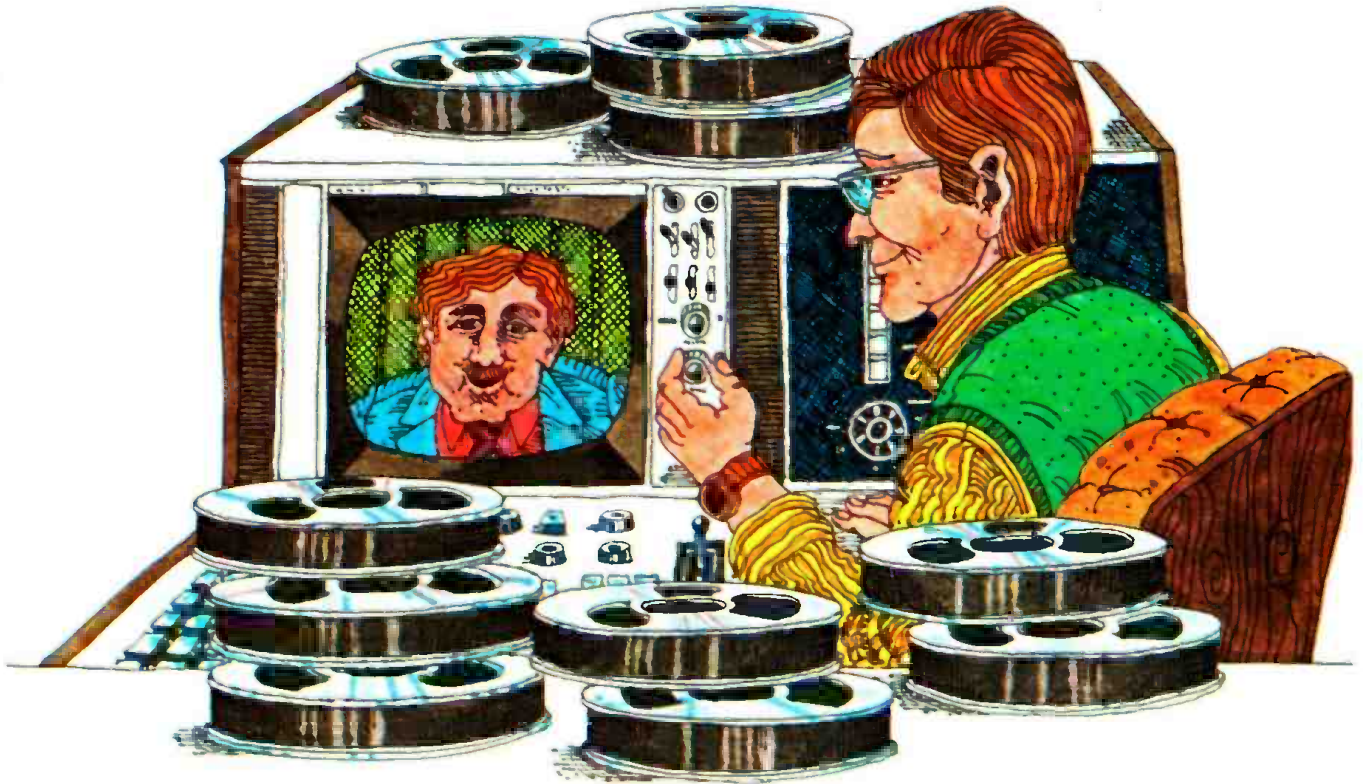

They got you an EDM-1.

Fully automatic, fully computerized electronic editing isn't anything at all like the hassle you've grown to hate. EDM-1 does everything but make the decisions about what goes where.

You'll probably buy your EDM-1 because it gives you total artistic freedom. EDM-1 even learns your very own "touch" in making fades, dissolves and other editing techniques. You tell the machine to watch how you do it, and then it'll imitate you every time, in video, audio or both.

The details are handled by computer. Addresses, pre-rolls, sequence listing, renumbering to accommodate insertions and

deletions, separate audio and video entrances and exits, even the master and slave VTR start and stop commands.

One EDM-1 and two VTRs (ideally AVR-3s) are all you need to create a masterpiece. Add more VTRs to the "source" library, and you may find yourself doing the incredible—you can initiate literally hundreds of edits and assemblies by pressing a single switch.

EDM-1 is the Ampex editing system for creative producers who can't take chances.



AMPEX

Complete technical and performance specifications are available in a free brochure. Write us at 401 Broadway, Redwood City, California 94063, or call (415) 367-2011.

Circle 100 on Reader Service Card

When you're shooting ENG, two things are certain: You never know where news will happen next. And you never know what will happen when you get there.

For the first, you need lenses with proven performance. The kind of versatility to handle most any kind of shooting situation. Plus the ruggedness and reliability to withstand daily use. And abuse.

For the second, you need lenses backed by *service*. To keep your lenses in top condition. And solve the problems no one can foresee, but everyone faces.

At Canon, we offer the widest selection of ENG lenses in the business. Premium lenses, engineered by the same people responsible for our Academy Award in lens design.

Built by the people who helped make our Scoopic camera the network newsman's favorite silent '16'. And backed by a dedicated

group of servicepeople, in key cities, nationwide.

When you're shooting ENG, you need more than lenses that work when the going's easy. You need lenses you can depend on. To reliably handle everything you'd reasonably expect to find on location. Backed by loaner lenses and quick-turnaround service when the unexpected shatters your peace of mind.

You need Canon.

For more information about Canon ENG lenses, please contact Jack Keyes or Ken Morishima in New York; Matt Miyazaki in Chicago; or Harry Hirai in Costa Mesa.

Canon U.S.A. Inc. Head Office:

10 Nevada Drive, Lake Success, N.Y.
11040 (516) 488-6700

140 Industrial Drive, Elmhurst, Ill. 60126 (312) 833-3070

123 Paularino Avenue East, Costa Mesa, Ca. 92626 (714) 979-6000.

Canon Optics & Business Machines, Canada, Ltd.

3245 American Drive, Mississauga, Ontario L4V 1 B8, Canada

Canon Amsterdam N.V. Industrial Products Division

De Boelelaan 8, Amsterdam, Netherlands

Corporate Sponsor, American Society of Television Cameramen

Canon[®]

SOMETIMES, THE NEWS CAN HAVE TOO MUCH IMPACT.

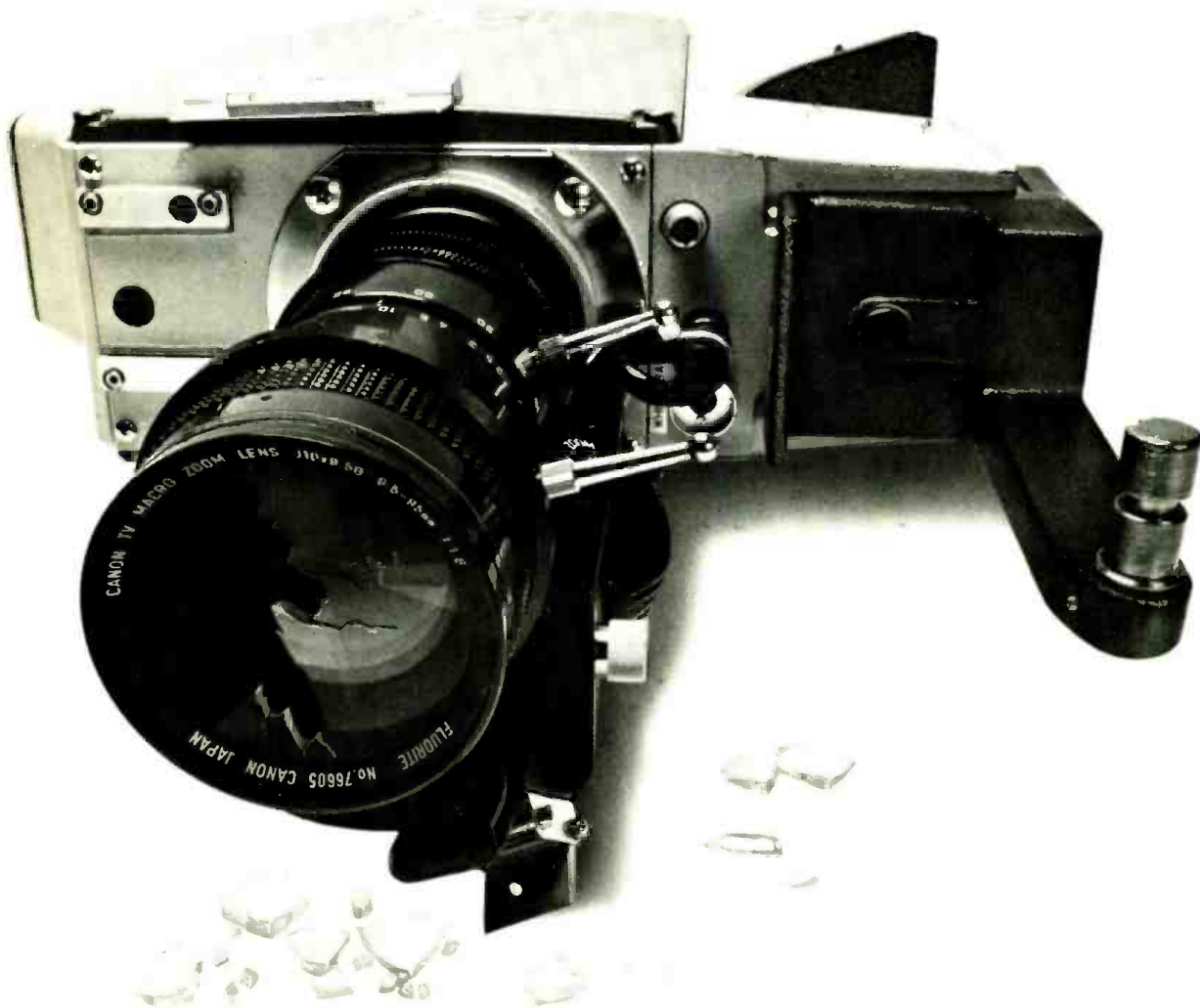

BM/E

BROADCAST MANAGEMENT/ENGINEERING

APRIL 1977/VOLUME 13/NUMBER 4

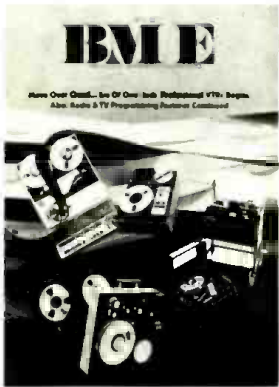

The promise of one-inch videotape formats, with their lighter weight, greater economy and greater portability, has been greeted with great interest from broadcasters. The standardization of formats, however, creates some potential problems for this new technology.

BROADBAND INFORMATION SERVICES, INC.
295 Madison Ave.
New York, N.Y. 10017
212-685-5320

Editor

James A. Lippke

Senior Editor

Robin Lanier

Associate Editor

David Hawthorne

Art Director

Gus Sauter

Manager

Publication Services

Djuna Zellmer

Editorial/Production Assistant

Janelle Seal

Controller

Sharon Van Leuven

Reader Service

Aetna Dowst

FCC Counsel

**Pittman Lovett Ford
and Hennessey**

Publisher

Charles C. Lenz Jr.

6 Broadcast Industry News

Mutual, NPR move toward broad use of satellites; Two-way cable system for public; The next big convention: Montreux Intl. Television Symposium, June 3-10, 1977

21 Radio Programming & Production For Profit

Talk radio is stronger every day

22 BM/E's Program Marketplace

Profile of Drake-Chenault, Inc.

26 Television Programming & Production For Profit

KPIX: "Evening—The MTWTF Show"

33 New One-Inch VTR Formats Go Into Action

Broadcasters and production houses are beginning to move to one-inch professional videotape recorders

44 ABC Constructs A Post Production Facility Where Audio Isn't Left Out

Audio is given a great deal of attention in one of the most sophisticated video post production installations

49 AM Stereo: If You Want It Now Is The Time To Tell The FCC

Testing of five AM stereo systems begins in April by the National AM Stereo Committee

57 NATPE Conference Produces Biggest Turnout Ever, New Trends And Some Controversy

More than 200 television programming executives, syndicators and producers met in Miami Beach where new trends, regulations, and high cost of business were the chief subjects

62 FCC Rules & Regulations

Licensee-conducted contests

66 Great Idea Contest

Send in your votes—and your ideas too!

70 Broadcast Equipment

BM/E's survey of new products



BPA BM/E, BROADCAST MANAGEMENT/ENGINEERING, is published monthly by Broadband Information Services, Inc. All notices pertaining to undeliverable mail or subscriptions should be addressed to 295 Madison Ave., New York, N.Y. 10017. BM/E is circulated without charge to those responsible for station operation and for specifying and authorizing the purchase of equipment used in broadcast facilities. These facilities include AM, FM, and TV broadcast stations; CATV systems; ETV stations; networks and studios; audio and video recording studios; consultants, etc. Subscription prices to others: \$15.00 one year, \$25.00 two years. Foreign: \$20.00 one year, \$35.00 two years. Foreign Air Mail: additional \$24.00. Copyright © 1976 by Broadband Information Services, Inc., New York City. Controlled circulation postage paid at East Stroudsburg, PA.

GRASS VALLEY GROUP 
M200

*A new, low-cost, standardized approach
to television switching automation employing
microcomputer technology.*



THE GRASS VALLEY GROUP, INC.
A TERTRONIX COMPANY

Station Plaza East
GREAT NECK, NY 11021
(516) 487-1311

4419 Van Nuys Blvd, Ste 307
SHERMAN OAKS, CA 91403
(213) 990-6172

1644 Tullie Cir, NE
ATLANTA, GA 30329
(404) 634-0521

P.O. Box 482
MABANK, TX 75147
(214) 887-1181

810 W Bristol Street
ELKHART, IN 46514
(219) 264-0931

BROADCAST INDUSTRY NEWS

Mutual, NPR Move Toward Broad Use Of Satellites

Two more major radio broadcast organizations, Mutual Broadcasting System and National Public Radio, have accelerated plans to move into broadscale use of satellites for distributing their programs across the country, following the legalization by the FCC of earth station antennas smaller than nine meters in diameter (*BM/E*, February).

Mutual, with about 750 affiliates nationwide, has been viewing satellites for some time as a cheaper, surer, more flexible distribution method, with higher "fidelity" than standard land lines. During the NAB in Washington (taking place after this was written), Mutual demonstrated an experimental satellite loop consisting of a telephone line to a microwave tower in Washington; a microwave link to the Western Union satellite transmitter in McLean, VA; a signal up to "Westar," the WU "bird"; and receipt of the signal from Westar with a three-meter earth station on Mutual's roof in Arlington. At an early stage of the system development, Mutual expects to have about 150 earth stations around the country; later this will probably increase to more than 300, strategically placed to serve all Mutual affiliates.

National Public Radio is also planning to take advantage of the lower cost, much higher fidelity available with satellites, and will emphasize the multi-channel capability of the system. NPR has asked contractors to bid on providing about 200 public radio stations with the capability to receive multi-channel programs, and on necessary enlargement of the PBS (television) satellite origination station to cover NPR's needs as well. NPR will be able to make use of DATE, the digital audio system developed by PBS which can put up to four topgrade stereo channels in digital form into a little less than 2 MHz of bandwidth; this can be duplexed into a video channel, for TV sound, or be used separately for radio. Contractors have been advised that all work on the NPR net must be completed by December 31, 1979.



Maison Des Congres in Montreux, Switzerland, will house exhibits from broadcasting manufacturers around the world. A N.A. contingent will be part of a BM/E organized exhibit.

The Next Big Convention: Montreux Intl. Television Symposium, June 3-10, 1977

The 10th International Television Symposium and technical exhibit in Montreux, Switzerland has all the signs of being the largest and best attended international television convention to date.

Similar to the 1977 NAB convention, all exhibit space is sold out and there is a waiting list of manufacturers that are anxious to penetrate the rapidly expanding world television equipment market.

BM/E is sponsoring a "Digital Developments '77" exhibit area for Montreux that will include an impressive list of manufacturers from North America: CMX Systems, Convergence Corp., Arvin/Echo Science, Farinon Electric, System Concepts, Telemet, Vital Industries and Ward-Beck Systems.

The *BM/E* Digital Developments '77 exhibit area will be over 2500 square feet and located in a specially constructed area on the terrace of the Montreux Convention Center and on the same floor with other international leaders, RCA, Fernseh, Thomson-CSF, Marconi and Harris-Gates.

Two-Way Cable System For Public

A new 30-channel two-way CATV service will be offered in late 1977 to approximately 100,000 homes in Columbus, Ohio, on the existing Warner cable television system.

Technical equipment to handle this multi-channel interactive system is currently being installed. The plant will be computerized and the subscriber will use a small home console connected to his set. The home console was developed by Warner engineers in collaboration with Pioneer Electronic Corp., of Japan.

The new service will offer a wide variety of programs and services, including special interest and local programming, utilizing the two-way communications capability. The subscriber will be able to use the system to receive 30-channels of video, information, select programs, play interactive games, take tests, instantly register his opinion, and actually participate at home in television programs and events.

Pay TV will also be available on an individual basis with programs billed automatically by the computer. Programs may be delivered to selected au-

continued on page 9

SQUEEZOOM

*new high technology
entry in switching
from VITAL*

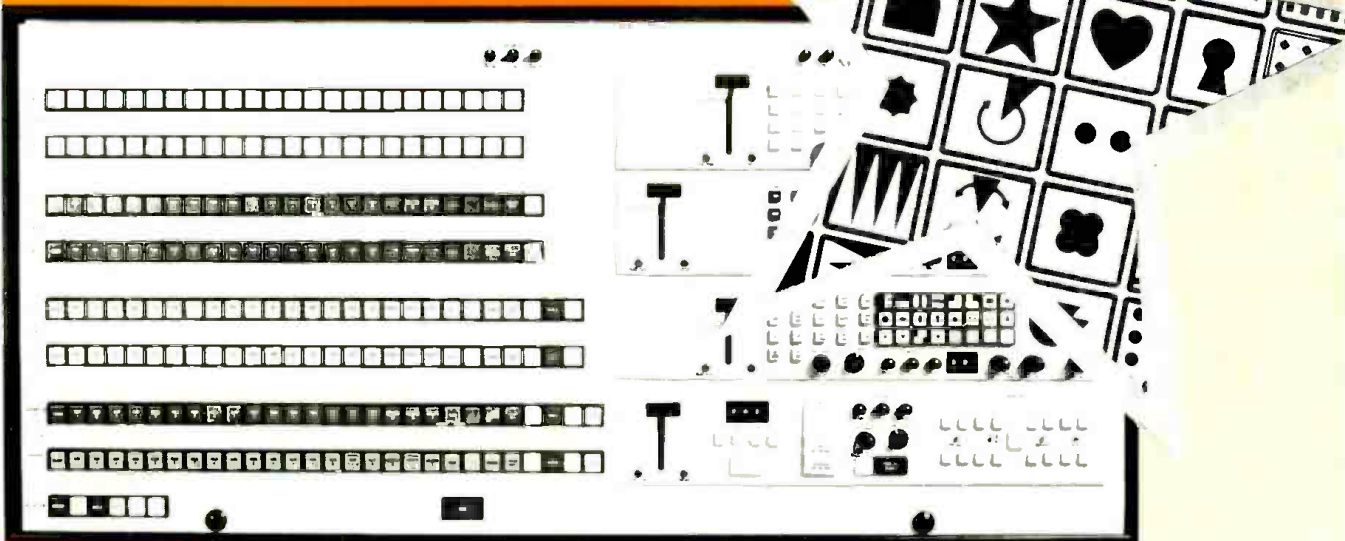

VIX-114

- 12, 16, 20, or 24 inputs. 4 bus, 6 bus, 8 bus or more bus systems.
- All digital waveform and quad split generators.
- Digital key edging, border, shadow and outline available on all ME's.
- Vari-key. Soft, hard, shadow, or see-thru key.
- Digital quad split. Wipe or dissolve in each quadrant.
- Electronic vignette. Adjustable soft pattern edges.
- Superb linear chroma keyer. RGB or encoded.
- Automatic transition control on each ME.
- Ready to interface for computer aided operation.
- Many more state of the art and operational features described fully in series 114 brochure

SQUEEZOOM[®] VMU-1

- Synchronizes up to 4 non-synchronizing NTSC color video signals simultaneously to studio sync.
- Continuously corrects variations in subcarrier phase from remotes or doppler effects from satellite transmissions.
- Full frame real time compression and zooming of pictures to any size.
- Joystick positioners place up to 4 compressed pictures anywhere on the screen.
- Microprocessor control for wider mode of operation.
- Real time freeze frame.
- Horizontal and vertical compression yield multiple effects.
- Zero delay in switcher.
- Eliminates tedious use of chroma keys in most cases.

PSAS^{*}

***Production Switching Automation System**
Ask us what it can do for you.

HI TECHNOLOGY PRODUCT INNOVATORS



VITAL INDUSTRIES, INC.

MAIN OFFICE: 3700 N.E. 53rd Ave., Gainesville, Fla. 32601 • Phone 904/378-1581

MORRELL BEAVERS Midwest
2644 North Seventh St
Terre Haute, Indiana 47804
Phone 812/466-3212

ROBERT McALL Northeast
34 Autumn Lane
Hicksville, N.Y. 11801
Phone 516/735-0055

GORDON PETERS Southwest
P. O. Box 912
Arlington, Texas 76010
Phone 817/261-6855

ERIC KING
Fox Hill Road
Lynchburg, Va. 24503
Phone 804/384-7001

BARRY HOLLAND West Coast
7960 West Beverly Blvd.
Los Angeles, California 90048
Phone 213/653-9438

Circle 102 on Reader Service Card

Amperex announces a new family of Plumbicon® tubes with 37% less lag*

When we first introduced the Plumbicon, its obvious superiority made it seem like the "ultimate" TV pickup tube. But in the dozen years since then we have produced a steady stream of advances in technology that have vastly improved its performance.

Now, with the new XQ1410 family of Plumbicons, we bring you the next step forward in pickup tubes for broadcast color: Internal bias lighting—resulting in a dramatic reduction in lag that conquers even the toughest low-key lighting conditions.

No more color fringing...vastly reduced picture smear...even better dynamic resolution than before—and all with the traditional Plumbicon's spectacular color performance.

Bias lighting has been offered before...as in our XQ1080, available for the past four years...but never in a fully integrated line of variable- and fixed-bias light tubes. The XQ1410 family is physically and electrically interchangeable with our industry-standard XQ1020 family. Only a minor field change is required to permit adjustment of bias light intensity if you use variable-bias tubes. (We supply complete instructions, of course.)

With bias lighting, the Plumbicon's near-zero dark current rises to a few nanoamperes to modify the target's beam-acceptance characteristics. The effect is to sharply decrease both rise time (signal buildup lag) and decay lag in all three channels. As shown below, the result of optimizing all three bias currents, in a "typical" camera, is a 37% reduction in lag.

Since the bias light intensity can be externally adjusted in each of the XQ1410 tubes...luminance (XQ1410L), red channel (XQ1410R), green channel (XQ1410G), and blue channel (XQ1410B)...all channels can be matched within the camera for identical lag characteristics, thus optimizing overall camera performance at levels never before achievable. The result: A new plateau in the quality of broadcast color. You'll have to see it to believe it.

For detailed information on our latest advance in the technology of the Plumbicon...the pickup tube used by 90% of all TV broadcasters...write or telephone: Amperex Electronic Corporation, Slatersville Division, Slatersville, Rhode Island 02876. Telephone: 401-762-3800.

IMPROVEMENT IN XQ1410 RISE TIME LAG PERFORMANCE with bias-light-induced dark current

At 50 ms, average % signal attained rises from 71.7% to 98.5%—a 37% overall improvement in rise time lag performance. Selecting optimum dark currents (e.g. Red = 4nA, Blue = 8nA, Green = 3nA) reduces spread in % signal attained from 39.5% to 3%—a 13X improvement in "incremental rise time lag."

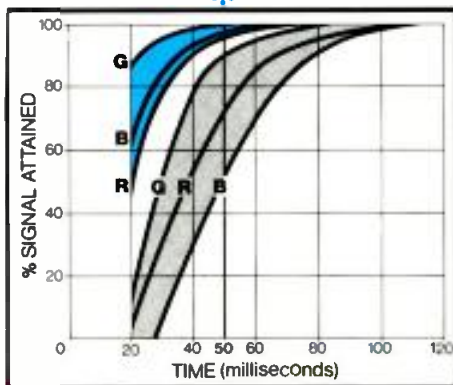

■ XQ1410's with bias light.
□ XQ1020's without bias light

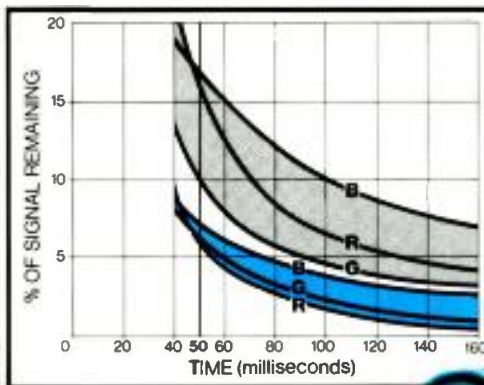

REDUCTION IN XQ1410 DECAY LAG with bias-light-induced dark current

At 50 ms, average % signal remaining falls from 15% to 7%—a 50% overall reduction in decay lag. Same optimum dark currents reduce spread in % signal remaining from 7% to 0.8%—a 9X improvement in "incremental lag."

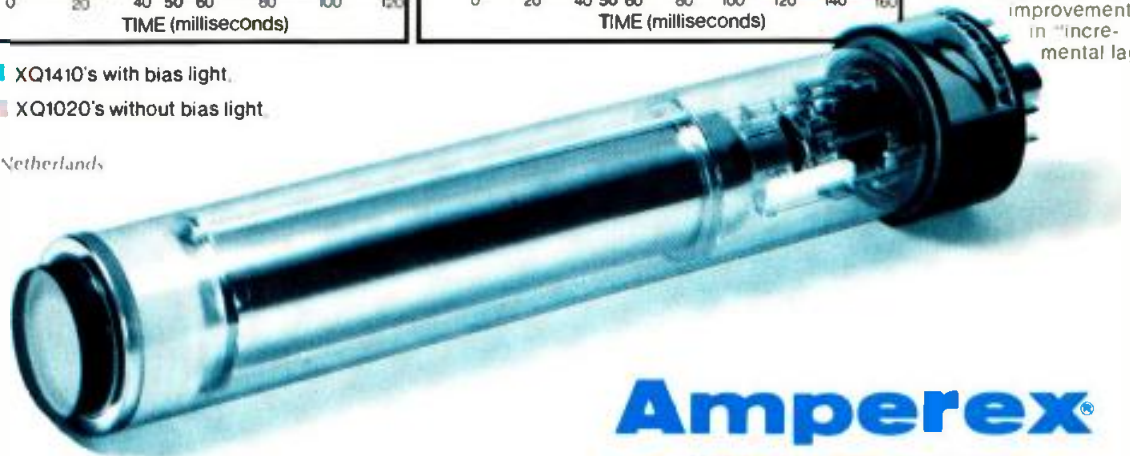

Amperex

TOMORROW'S THINKING IN TODAY'S PRODUCTS

A NORTH AMERICAN PHILIPS COMPANY

For further details and applications information, send for Bulletin No. 31.

Circle 103 on Reader Service Card

News

diences on a closed circuit basis with only authorized sets able to view the program. Home fire protection and security systems will be possible.

This innovative program that sounds more like the "blue sky" expectations of CATV raised years ago, was part of a development project made up of numerous experts from various fields including CATV, broadcasting, engineering, research, programming, and many other areas.

A new division of Warner Cable has been set up to carry on the project. It will be headed by Lawrence B. Hilford.

New Members Elected to NAB Radio & TV Boards

The NAB announced the election of 19 prominent broadcasters from across the nation to membership on its Board of Directors.

The 30 member radio board picked up 13 new members and the 15 member TV board picked up six in the mail balloting. Each member will serve two-year terms, which began March 30th.

Elected to the radio board were: Arnold S. Lerner, president, WLLH/WSSH, Lowell, MA; Jerry Lee, president, WDVR (FM); Paul Reid, president and GM, WBHB, Fitzgerald, GA; Walter E. May, president, WPKE/WDHR, Pikeville, KY; Charles E. Wright, president and GM, WBYS AM/FM, Canton, IL; John G. Lemme, president and GM, KTLF, Little Falls, MN; Stan McKensie, president and GM, KWED AM/FM, Seguin, TX; Frank W. McLaurin, V.P. and GM, KSRO, Santa Rosa, CA; Ted A. Smith, president and GM, KUMA, Pendleton, OR; Virginia Pate Wetter, president and GM, WASA/WHDG, Havre de Grace, MD; Daniel W. Kops, president, Kops-Monohan Communications, Inc., New Haven, CT; Bill Sims, president, KOJO/KIOZ, Laramie, WY; and Edward O. Fritts, president, WNLA AM/FM, Indianola, MS.

Those elected to the TV board were: Leslie G. Arries, Jr., president, WBEN-TV, Buffalo, NY; Bill Bengston, V.P. and GM, KOAM-TV, Pittsburg, KA; Thomas E. Bolger, president, WMTV, Madison, WI; Eugene B. Dodson, GM, Gaylord Broadcasting Co., WTVT, Tampa, FL; Robert B. McConnell, president and GM, WISH-TV, Indianapolis, IN; and Mike Shapiro, president, Belo Broadcasting Corp., WFAA, Dallas, TX.

WARC Draws Plan For Broadcasting Satellites

The 1977 World Administrative Radio

Conference, concluded in Geneva February 13th, drew up plans for allocating the frequency band 11.7—12.2 GHz in Regions II and III and 11.7—12.5 in Region I for the use of Broadcasting Satellite Services.

The intention of this year's WARC was to develop a plan for the allocation of this spectrum portion to various countries in the three regions and the representatives of Region I (USSR, Europe, and Africa) and Region III (Asia and the Pacific) came determined to finalize such allocations. The representative of Region II (North and South

America), particularly the U.S. and Canada, came determined to delay the actual assignment of specific channels preferring to formulate a "planning approach which would ensure the full development of the 11.7—12.2 GHz band by the Broadcasting and Fixed-Satellite Services on a co-equal basis."

The Region II plan backed by the U.S., Canada, and Brazil sought an "evolutionary plan" that would allow the sharing of the band by both fixed and broadcasting satellites because slots for the domestic fixed satellites are

continued on page 12



Nobody has it like the NEW Spotmaster 5300 A Three Deck

When we say "Nobody has it like Spotmaster," we mean it.

Here's the most advanced three deck on the market. It's our up-dated 5300A with *plug-in* decks for unsurpassed accessibility; and a new internal mechanical design which insures stable and accurate deck and capstan positioning independent of front panel reference. And note the run lights next to each deck.



All leads to the deck go through this plug-in connector.

More features? A premium, direct drive hysteresis synchronous motor; reliable low voltage, solid-state, solenoid switching, the superb Phase Lok III head bracket, FET muting, active cue tone filters and rear panel LED service aids. It's all there in the new Spotmaster 5300A.

For information call or write Broadcast Electronics, 8810 Brookville Rd., Silver Spring, MD 20910. Phone: (301) 587-1800.

BROADCAST ELECTRONICS, INC.

A FILMWAYS COMPANY



Circle 104 on Reader Service Card

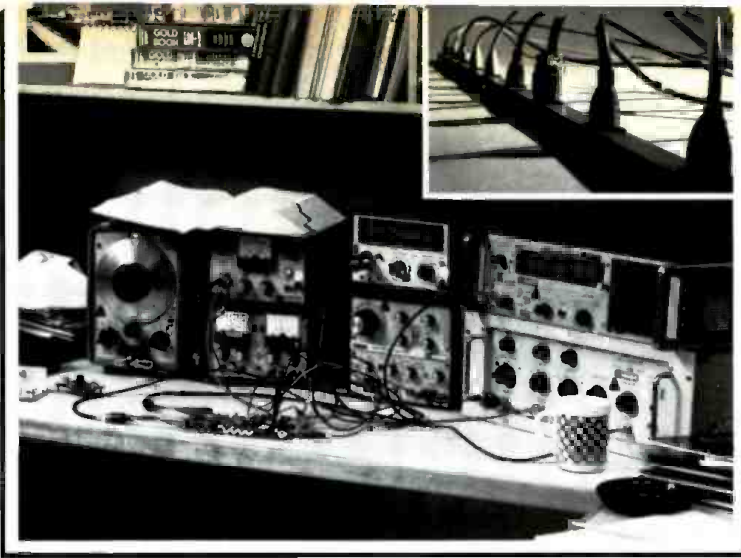

Here's an idea that could change your thinking about test equipment.

A complete test station doesn't have to be an assortment of special-function instruments. A working workbench doesn't have to be crowded and unhandy. And a truly portable test lab doesn't have to be out of reach.

TM 500 offers you an alternative: a modular line of compact, interchangeable plug-ins and mainframes. Multiconfigurable both in packaging and in performance, TEKTRONIX TM 500 is designed around the idea that test equip-

ment which is compatible in every respect can, in fact, cover a broader range of functions and meet a wider variety of measurement situations. To say nothing of its ability to adapt more readily to new challenges.

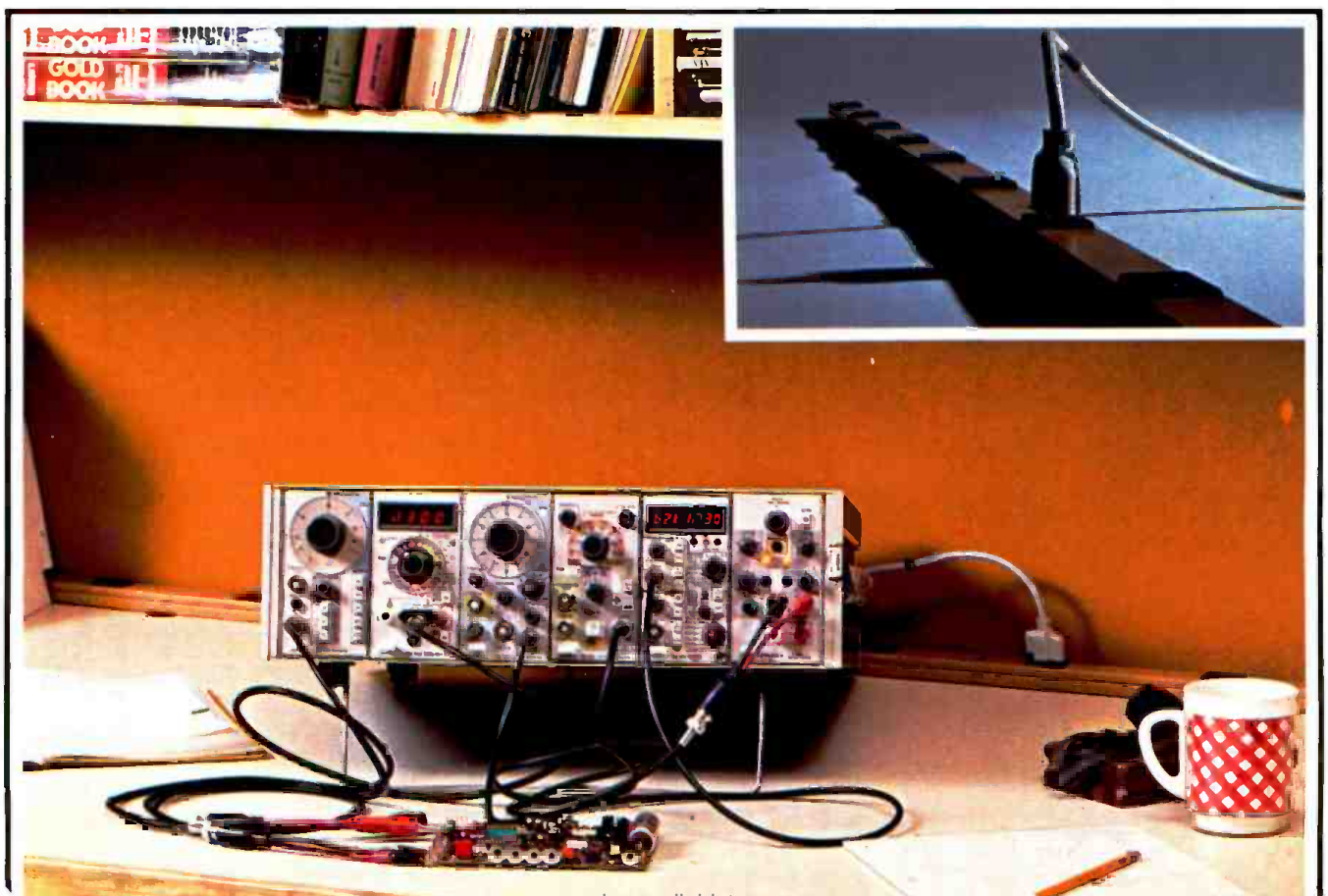



Modular DMMs, counters, generators, amplifiers, power supplies, oscilloscopes, logic analyzers, and word recognizers can be interfaced electrically. Signals



can be routed from one plug-in board to another via the mainframe mother board, thus enabling you to build a test instrument that's more powerful than the sum of its parts.

The plug-ins can be configured together in six widths of mainframe and four types of packages, depending on where and how you'll use them. Select the plug-in modules you need just as you would monolithic instruments, and then combine them in the appropriate mainframe for a

convenient, uncluttered bench setup; mount up to 6 functions



side-by-side in a 5¼-inch rack; build a rollabout station that "follows" you around the lab. Or



pack a portable test station in the small-as-a-suitcase TM 515 Traveler Mainframe, which carries up to 5 modules and typically weighs less than 35 pounds, including the modules.

The result is a total test system that looks like a unit . . . works as a unit . . . yet is still configurable to new or changing measurement requirements. So the next time you're looking into test instrumentation, specify the one product line that's designed for configurability.

For further information or a demonstration of TM 500 Instrumentation, write or phone: Tektronix, Inc., P.O. Box 500, Beaverton, Oregon 97077, (503) 644-0161 ext. 5283. In Europe: Tektronix Limited, P.O. Box 36, St. Peter Port, Guernsey, Channel Islands.

Tektronix
COMMITTED TO EXCELLENCE

TM 500...designed for configurability.

Circle 105 on Reader Service Card

www.americanradiohistory.com

already scarce and the parties did not want to get committed to an allocation scheme that might not be flexible enough to accommodate technological development. The developing countries of the Western Hemisphere did not back this plan for fear that if an evolutionary scheme were approved, available slots might be gone by the time they were prepared to launch their own satellite systems.

A compromise was reached whereby the U.S. and other supporters of the evolutionary plan are permitted to use this concept but must have a full plan by the 1982 WARC.

Regions I and III did formalize an allocation scheme and determined specifications such as the footprint dimensions. Some 947 channels were divided amongst the countries in these regions with smaller countries getting fewer channels and larger countries getting more. The plan to some extent is governed by the size of the satellite footprint. In countries as large as The Peoples Republic of China, as many as 55 channels can be accommodated whereas in smaller countries such as Switzerland, perhaps only four or five channels can be accommodated presuming that a single satellite will carry

that many transponders (one channel per transponder).

NCTA Calls For End Of Exclusivity

NCTA has called on the FCC to end the so called "exclusivity rules" which protect certain syndicated television programs and movies from being carried by cable when they are already available from over-the-air broadcasters in the same market.

According to the NCTA statement, five years of experience with exclusivity rules, makes it clear that the FCC's rationale for them was based on false assumptions. The Commission's fears of cable's economic impact on broadcasters has not been justified, according to NCTA, and the primary function of the rules has been supplanted by the new copyright law.

The rules require large portions of imported distant independent signals to be blacked out, especially during prime time, and have thereby contributed to cable's slowed growth.

Violence Up In FV Time- NAB To Formulate New Approach

According to this year's annual "violence profile" prepared by the Annenberg School of Communications at The

University of Pennsylvania, the incidence of violence took its biggest jump in family viewing time.

The report, according to project director, George Gerber, also indicated that violence "increased sharply last year on all three networks," reaching the highest over-all level since 1967. Most violent in FV time was ABC, while CBS was accused of "lifting the lid" on violence during early evening hours, and NBC was accused of the most violent children's weekend fare.

The problem has not gone unnoticed by broadcasters and since the courts struck down the family viewing agreement, NAB has taken some action to find alternatives. Wilson C. Hearn, chairman of the Joint Board of Directors of NAB, said in an appearance before the House Commerce Committee on Communications, that NAB is formulating a policy to reduce the amount of sex and violence on television. Such a plan, said Hearn, could be ready by summer with the cooperation of networks and program producers.

The NAB Board has directed the Television Code Review Board to formulate clear, strong advisory guidelines. NAB representatives, said Hearn, have met with program producers and the three networks and report

continued on page 14

On the Air®



TV TRANSMITTERS

TV TRANSLATORS

TV AMPLIFIERS



acrodyne
industries, Inc.

21 Commerce Drive • Montgomeryville, Pa. 18936
(215) 368-2600 TWX 510-661-7285

Circle 106 on Reader Service Card

Audio Heads? Get on the Beau bandwagon.

There must be some reason why the reaction to Beau mono and stereo audio heads has been so enthusiastic and widespread. There is: Quality and price. From the maker of Beau motors and Beucart®



audio cartridge tape machines, Beau heads are equal to anything else on the market. But at \$19.00 for mono models and \$69.50 for stereo units, Beau heads are unquestionably the biggest bargain around. Heads either with no mounts or threaded studs with leads, right from stock, are available for all popular cart machines, including Ampro, ATC, Beucart, Collins, Garron, Harris/Gates, ITC, RCA, Sono-Mag, Sparta, and Spotmaster. And if you can find another quality broadcast cart machine, we'll provide heads for it, too.

For a listing of all Beau audio heads, please request our new head brochure. Call (203) 288-7731 or write today.

UMC

**BEAUCART DIVISION
UMC ELECTRONICS CO.**
460 Sackett Point Rd. North Haven, CT 06473

Circle 107 on Reader Service Card

"YOU KNOW THIS NEW 3M SWITCHER IS REALLY PERFORMING BEYOND MY WILDEST EXPECTATIONS."



Sorry, our switchers really can't pop a super lady out of your tube...yet. But they can sure help you make better lookin' programs.

On our economical compact **Model 1114 Production Switcher**, you can make almost all the moves the network guys do. You can preset your wipes to any vertical or horizontal level in any effect pattern, joystick position them, modulate, soft wipe, spot light, or fade to any color or black. Preview and Program output switching lets you set up your effects before they go on-line. The Model 1114 is 100% vertical

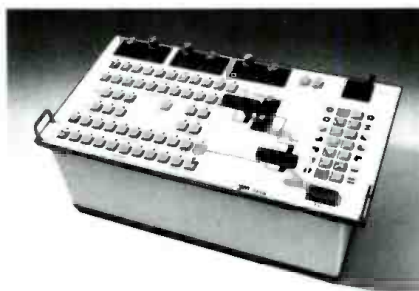

interval switching on all four busses and fourteen special effects, and includes eleven inputs and an optional Chroma Keyer.

Our new, low cost **Model 812 Production Switcher** includes three busses, twelve effects, eight

Circle 108 on Reader Service Card

inputs, and many of the standard features of the Model 1114. Special features of the Model 812 include a Digital Event Timer and a Non-Sync warning light.

With either the Model 1114 or the Model 812 you'll switch up to quality video for a lot less money.

For more information about our full line of 3M Production Switchers and a frameable 11" x 14" full color reprint of the illustration in this ad, write: 3M Mincom Video Products, Bldg. 223-5E, St. Paul, Minnesota 55101 or circle our number on the reader service card and return.

3M
COMPANY

that both groups expressed concern over the problem and a willingness to work with NAB to develop new and effective methods of self regulation.

Meetings between the Code Board and representatives of the National Citizens Committee for Broadcasting and the American Medical Association are scheduled for late March. A meeting with the PTA is also expected.

A Spanish language radio station in Miami, Fla., has **lost its license and been forced off the air** by order of the FCC. The station, WFAB, was found guilty of "double billing" based on a charge leveled in 1974. Plans to appeal the ruling and expected legislative action by Florida congressmen did not materialize in time to prevent the station from going off the air.

Stephen Trivers, president of WQLR, Kalamazoo, has been named

convention chairman for the 1977 NRBA conference planned for October 9-12, to be held in New Orleans The Practising Law Institute of New York City has announced plans to hold **two seminars on Current Developments in Copyright Law**. The first will be held at the Biltmore Hotel, New York, May 18-20, and the second will be held at the Beverly Hilton Hotel, Los Angeles, June 1-3.

"Chip" Shooshan, counsel and staff director of the House Subcommittee on Communications, **called for greater participation by engineers in the upcoming rewrite of the 1934 Communications Act** and for the elimination of artificial barriers between the legal and engineering professions. A step in that direction has been the appointment of Charles Jackson, former assistant to the Chief of the FCC Common Carrier Bureau, as engineering assistant to the subcommittee.

In an effort to "move the legal system of Georgia into the 20th Century," the Chief Justice of Georgia's Supreme Court, H.E. Nichols, said that the state would experiment with the use of **TV cameras and photography to report court proceedings**, at least at the appellate level The city of Waco, Texas has granted a **new CATV franchise without rate regulation** to Waco Cablevision. This is one of the first such franchise agreements in the country and Bill Daniels, chairman of Daniels Properties, parent company of Waco Cablevision, said, "We will not take advantage of our new freedom . . . and we will pursue similar franchise agreements in the other cities where we operate systems."

A **new dues structure favoring medium sized cable TV systems** has been announced by NCTA. The new structure will reduce the dues of single and multi-system operations with 20,000 to 200,000 subscribers; increase slightly for systems with more than 200,000 subscribers and leave systems with 20,000 or fewer subscribers unchanged.

The NCTA Board of Directors has approved a **\$10,000 grant to support development of minority cable franchise holders** in their efforts to recruit membership and develop their own American Association of Cable Television Operators CSAE, a nationwide research association of 40 CATV operators, has launched a study for a prospective **new communications network** that would develop and deliver programs via satellite to cable subscribers from anywhere in the world. CSAE has contracted with Bradley Associates, a new consulting firm, to develop plans for the network.

The **27th Annual Broadcast Industry Conference** will be held on the

continued on page 16

TO MAKE IT PERFECTLY CLEAR

.... YOU NEED MULTILIMITER

Multilimiter is the broadcast limiter that's designed to keep your sound clear, clean, and out front . . . so you can REALLY listen to what you're hearing.

The only way to judge Multilimiter is with your own ears. Call us today for details on our 21 day trial plan. Phone 714-453-3255.

Listen to Multilimiter . . . NAB Booth 549, Shoreham Americana . . . we think you'll like what you hear!

PACIFIC RECORDERS AND ENGINEERING CORPORATION
 11100 ROSELLE ST., SAN DIEGO, CALIFORNIA 92121
 TELEPHONE (714) 453-3255 TELEX 695008

Circle 109 on Reader Service Card



Introducing a Color Corrector for Electronic News Gathering.

Electronic News Gathering makes tough demands upon the broadcaster. Color imbalance and colorimetry problems are frequently encountered. Matching remote camera shots to indoor studio programs or assembling tapes from different locations or cameras is "chancy" at best. Often that fast-breaking story doesn't allow for camera rebalancing!

Thomson-CSF Laboratories now provides a solution to such difficult encoded signal color problems. With the Model 5500A Color Corrector, you'll be able to rebalance and match video signals *after* encoding. It can be used either after the play-back tape machine or following the microwave receiver during live coverage. In most cases, a noticeably improved color picture will result. For ease of operation, a Remote Control unit is included as standard equipment.

As an added feature, an optional automatic Sensor unit is also available to control the Color Corrector for telecine use.

Whether for Electronic News Gathering, tape production or telecine use, the Thomson-CSF Laboratories Color Corrector System should be working for you. Interested? Give us a call.



THOMSON-CSF LABORATORIES, INC.

37 Brownhouse Road, Stamford, Connecticut 06902

(203) 327-7700 / TWX (710) 474-3346

Circle 110 on Reader Service Card

The AUTOMATIC Audio Test System That Measures. . .

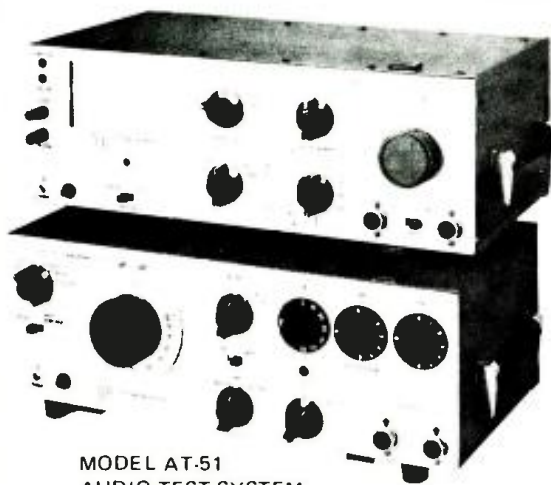

MODEL AT-51
AUDIO TEST SYSTEM

- Harmonic Distortion
- Intermodulation Distortion
- Volts
- dB
- Signal + Noise / Noise Ratio
- Wow and Flutter
- Stereo Phasing
- Differential Gain in Stereo Channels

Contact Us Now For Complete
Details And Descriptive Literature.

POTOMAC INSTRUMENTS

932 PHILADELPHIA AVE.
SILVER SPRING, MD. 20910
(301) 589-2662

Circle 111 on Reader Service Card



JOIN

... the many hundreds of satisfied users of
- LPB Signature Series Consoles.
Contact us for the reasons that have made LPB Consoles the
practical choice among broadcasters.

LPB®

LPB Inc.
520 Lincoln Highway, Frazer, PA 19355 (215) 644-1123

Circle 112 on Reader Service Card

News

campus of San Francisco State University April 24 through April 29. The conference, entitled "The Broadcast Media: Creators or Reflectors," will begin with an awards ceremony recognizing individuals who have contributed to the industry.

"Euro Comm 77" exhibition and conference will be held in Copenhagen, Denmark, June 7-9. Subjects to be covered will include holography, teleconferencing, tele-transport, tele-text, and fiber optics, among other new technologies. Information on attending the conference can be obtained by writing, Bella Center A/S, Center Blvd., DK-2300 Copenhagen S, Denmark.

Business Briefs

Dynair Electronics, Inc., has moved to new larger quarters at 5275 Market Street, San Diego, CA **Teleprompter Corp.**, announced it has closed an agreement with **Hughes Aircraft Company** to form a joint venture to operate cable TV systems jointly owned in Los Angeles and northern Manhattan **Insilco Corp.**, and **Fiber Communications Inc.**, have signed an agreement creating **Times**

Fiber Communications Inc., a new company in the fiber optics field. Irving Kahn will be director of the parent corporation, Fiber Communications Inc.

The Outlet Company announced it has filed an application with the FCC for a construction permit to operate a UHF TV station in Oklahoma City, Oklahoma, the nation's 37th largest TV market. If the application is granted the new station would be Outlet's sixth station. Outlet currently owns 5 VHF stations.

WICZ-TV, a division of **Stainless Inc.**, North Wales, PA, broke ground for a new 8000 sq. ft. facility in Vestal, NY **Time & Frequency Technology, Inc. (TFT)** has opened a new sales office at 109 Penn Street, Riverton, NJ; Tom Creighton has been appointed to head the new office.

Zenith Radio Corp., has reached an agreement in principle with **Sony Corporation of Japan** for the rights to market and produce video player/recorders based on the tape scan technology of the Betamax **Scientific-Atlanta** has received a contract for three 5-meter Receive-Only Earth Stations from **Clearview Cable TV**, a division of Westinghouse Broadcasting Company.

KVC, a New York City based video equipment rental firm has taken on **Video Pod**, a completely self-contained

continued on page 18

**RCA
DOESN'T HAVE IT.**

**COLLINS
DOESN'T HAVE IT.**

**HARRIS
DOESN'T HAVE IT.**

You won't find a toll-free telephone number in their ads. But with The New CCA you will. For sales *and* service. It's another indication of our new vitality, our new thrust, our new excitement at CCA. And, that The New CCA *means* business. And service.

See our new products and meet our new people. Join us at the NAB — Booth 201, Sheraton Park.

**ONLY
The New CCA!
HAS IT.**

**800-257-8171
FOR SALES AND SERVICE
In Canada: 800-261-4088**

CCA Electronics Corporation • 716 Jersey Avenue • Gloucester City, N.J. 08030 • Telex: 845200

Circle 113 on Reader Service Card

NOW
6dB Greater Output
 with **HOT TAPE**
 exclusively from

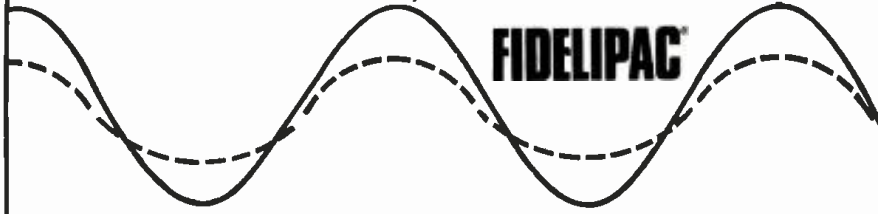

Cartridge tape quality equal to that of the finest professional reel-to-reel mastering types . . . **HOT TAPE**—High Output Transfer Tape—delivers up to 6dB greater output over types used in most broadcast cartridges to date. That means: dramatically reduced tape hiss . . . greater headroom for less audibility of audio system white noise components . . . increased signal saturation for decreased IM and other distortions. But, **MOST IMPORTANT**, you get studio perfect reproduction of music and commercial spots.

Hot Tape is available to special order in all factory loaded Fidelipac Cartridges or in bulk for reloading. For details, contact your Fidelipac distributor today or



FIDELIPAC®

109 Gaither Drive • Mt. Laurel, NJ 08057 • (609) 235-3511

® Trademark

Circle 114 on Reader Service Card

TELE-PAT PRECISION TEST SLIDES
PUT YOU RIGHT IN THE PICTURE

Whether you're a top network station or an independent videotape producer, the picture your viewers see must be clear, sharp and color-true. There's only one way to make sure—and that's to check and align your TV cameras regularly with Tele-Pat precision test pattern slides.

Tele-Measurements provides 17 different test patterns in two sizes. The 100 series slides are 2" x 2" in size, for film multiplexers and spot scanners. The 300 series are 8 x 10" for use with Tele-Pat test pattern illuminators. Series 200 and 400 are special color patterns, and series 500 are customer specified slides, available on special order.

All test slides are mounted in optical glass and are electronically accurate to $\pm 1\%$ of vertical and horizontal tolerances. Test patterns include:

TM-101 & TM-301 Resolution Slide (Retma). Standard reference for measuring resolution, testing for streaking, interlace, shading scanning linearity, and aspect ratio. Horizontal and vertical wedges with 200 to 800 line resolution

TM-102 & TM-302 Resolution/Extended Gray Scale. Same as TM-101 and TM-301, with the addition of four logarithmic gray scales for transfer characteristic testing

TM-202 & TM-402 Color Fieshtone Slide. For overall color performance and set-up purpose

TM-501 Station I.D. Color Slides. Supplied with your station call letters, channel, and location. Professional identification for local monochrome and color programming

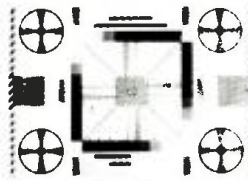

For a complete list of Tele-Pat test pattern slides and illuminators, call or write



TELE-MEASUREMENTS INC.

145 Main Avenue, Clifton, New Jersey 07014
 (201) 473-8822 (212) 581-9020

Circle 115 on Reader Service Card

News

videotape production unit which can be shipped via widebody or cargo jet to any location. The unit may be transported by flat-bed truck and works with minimal set-up . . . Tulsa, Oklahoma now has the largest sound stage in the Southwest. The just completed million dollar film and recording facility, **Tulsa Studios**, is at 6314 East 13th Street in that city.

Philips Test & Measuring Instruments, Inc., has relocated to larger facilities in Mahwah, NJ. The new address is 85 McKee Drive, Mahwah, NJ 07430, telephone: (201) 529-3800

Skirpan Lighting Control Corp., has opened a new office in North Hollywood, CA. The mailing address is PO Box 4632, No. Hollywood, CA 91607. Robert Slutske has been named to head the new facility.

Data Devices International, Inc., has acquired for cash the winder/cleaner/certifier product line of the **Mincom Division of 3M Company**.

FCC Briefs

TV channels 7 through 13 have been opened to use for wireless microphones, under FCC order effective March 31, 1977; transmitters are limited to 50 mW and channels must be employed that avoid interference with TV licensees in each area . . . The FCC deferred from March 1st until May 2 the deadline under which existing cable television systems which have not done so must file certificates of compliance . . . What may be the first person to go to jail for illegal CB activity is Lewis L. Simpson of Indianapolis, who got a year in prison for transmitting obscene language and six concurrent months for illegal operation.

The FCC notes that the 50 top markets subject to the prime-time access rule will lose, in 1977-78, Norfolk-Portsmouth-Newport News-Hampton, Va.; and Greensboro-Winston Salem-High Point, North Carolina; and will gain Toledo, Ohio, and Salt Lake City, Utah . . . Meanwhile, the Commission opened a rule-making for a proposed 34 month gap in the period between the issuance of the Arbitron rankings and the establishment of the list, so that stations moving in or out would have time to make appropriate changes in program commitments. (Comments April, 15.)

Two rulemakings of major importance on which comments are currently invited are: Clear Channel Broadcasting (*BM/E*, March 1977), a comprehensive look at everything to do with networks, with potential for basic changes in broadcasting, comments due May 2, 1977.

the AMERICAN DATA

558-1

NEW FOR '77!



The 558-1 is a compact video processor that provides small studio and remote van operators with production capabilities found only in large studio systems. *Four Channel Parallel Video Processing* allows mix, wipe, luminance key, and chroma key functions to be performed *simultaneously* on a single mix/effects amplifier. This *revolutionary approach* to video systems flexibility is a continuation to the fourth generation of production switchers *pioneered by American Data*.

standard features:

- Nine primary inputs, including blackburst, plus five external key inputs.
- 100 soft wipe patterns, including rotational wipes; H and V multipliers; pattern positioner; pattern modulator, soft bordered wipes.
- Spotlight with 0-100% variable attenuation.
- Three independent key processing systems.
- Adjustable rate key blink; key invert.
- Two independent color matte generators.

- Full camera tally.
- Available for NTSC, PAL, PAL-M standards.

options:

- One Bus Quad Split.
- Linear RGB chroma keyer and camera input selector.
- Two key edge generators.
- Third color matte generator.



AMERICAN DATA

401 WYNN DRIVE • P. O. BOX 5228 • HUNTSVILLE, ALABAMA 35805 USA • TELEPHONE 205 837-5180 • TWX 810 726 2125

ADC SOUTHEAST
705 Bowie Blvd.
Orange Park, FL 32073
904-269-2544

ADC MID-WEST
233 West Hill Ave.
Glenn Ellyn, IL 60137
312-469-6200

ADC MID-ATLANTIC
5504 Waterway
Rockville, MD 20853
301-460-1454

ADC WEST
445 S. New Hampshire
Suite 301
Los Angeles, CA 90020
213-387-7756

Circle 116 on Reader Service Card

It's a very good year...



to buy Belar.

There were always lots of good reasons to buy Belar . . . now we can give you many more. Like our new automatic Stereo Monitor, shown above.

We're introducing a line of new products that will set new standards of performance in broadcast monitoring. Each piece of equipment has been Belar-engineered to remain state-of-the-art for years to come. And, of course, our monitoring systems are suitable for ATS.

Check our new equipment and see why we say this is a vintage year. Buy Belar today . . . in ten years, you'll still be thanking yourself.

- Our new **FM Modulation Monitor** features a sample-hold and absolute magnitude peak detector circuit to capture and display all the program peaks on the modulation meter.
- Our new **Digital FM Modulation Monitor** features a continuous LED display to instantaneously indicate program peaks.
- Our new **Stereo Monitor** features two sensitive auto-ranging voltmeters for simplified automatic measurement of stereo separation and crosstalk.
- Our new **SCA Monitor** features an auto-ranging voltmeter for simplified SCA measurements.
- Our new **Digital FM Frequency Monitor** includes off-frequency alarms for carrier, 19 kHz pilot, and SCA frequencies.
- Our new **FM RF Amplifier** maintains full stereo performance with the ability to select any channel.
- Our new **Digital Clock** provides the necessary timing function for ATS.
- Our **AMM-2 AM Modulation Monitor** features three peak lights and outputs for ATS modulation control.
- Our **AMM-3 AM Modulation Monitor** features separate meters and four peak lights for negative and positive modulation, and also includes outputs for ATS modulation control.
- Our new **AM Frequency Monitor** includes ± 10 Hz and ± 20 Hz off-frequency alarms, and a loss-of-count alarm.
- Our new **AM RF Amplifier System** permits reliable monitoring with our new shielded loop in a field of 50 microvolts per meter.
- Our new **Automatic Power Controller** provides power correction and alarms for ATS.
- Our new **Mod-Minder** provides automatic modulation control and alarms for ATS.
- Our new **Status Alarm System** starts with two statuses and can be expanded to over 900 statuses.



BELAR ELECTRONICS LABORATORY, INC.

LANCASTER AVENUE AT DORSET, DEVON, PA. 19333 • BOX 826 • (215) 687-5550

When Accuracy Counts . . . Count on Belar

Circle 117 on Reader Service Card

RADIO

PROGRAMMING & PRODUCTION FOR PROFIT

Talk Radio Is Stronger Every Day

In this fourth installment of *BM/E*'s new department on radio programming, we are drawing attention mainly to a few of the available talk shows. The success of talk radio is the outstanding development of the moment. There is discussion among a number of talk stations about a national association, in which members could help each other with program suggestions and exchanges, stimulate talk program production. The story of WMEY in Boston is one of many: following an audience survey carried out in the area by the University of Hartford, showing a 50% audience approval for talk shows, WMEY went completely to talk—and climbed about 14 slots in the ratings. *BM/E* will tell that story in more detail in a future issue, along with those of other stations. Here we are pointing out a few more program sources that some station managers may have overlooked.

Consumer guidance, jazz, science, foreign news

PROGRAMS OF ASTONISHING variety, ranging from a "hep" jazz-and-comment show, through consumer guidance in interviews with many distinguished authorities, to tours of culture in countries around the world, are for rent from the Broadcasting Foundation of America, at 52 Vanderbilt Ave., New York, NY 10017.

It is likely that many managements are not aware of the scope of the programming collected by this 20-year old non-profit organization. The operation plan of BFA has not included a

large promotion effort which would draw strong attention to their offerings. The objective of the founders was to act as a conduit and staging center for programs that seemed to them of especially high quality, to actively seek out such programs and get them into the radio pipe line. It is chartered as an educational institution by the regents of the State of New York.

But "educational" applies in this case only in a broad sense. BFA has many programs with very high informational value, and a number that are pure entertainment. What links them, in almost all cases, is that they do not attempt to compete with the general run of popular, commercial music, comedy, sports, etc.

In that difference lies the value of such programming for the station manager looking for a "mix" with some variety, some uplift, some solid information that will create respect and interest among his listeners. Here is a quick rundown of some of the main BFA programs (interested program directors should write BFA for a complete catalog):

Midnight Special — One hour a week of jazz, folk music, and humorous comment (the show originated by Mike Nichols), now heard from New York to Singapore, with Norm Pellegri and Ray Nordstrand as hosts.

The Studs Terkel Show — Comment and interviews by a best selling author, with celebrities and some not so celebrated.

This is Your World — Environmental situations, ecology, social change, by experts around the world.

The International Science Report — Visits to research centers around the world. Leading scientists comment in person.

Panorama of the Lively Arts — Documentary, interview approach to films, painting, music, theater around the world.

Conversations for Consumers — This is one of the highest rated Sunday programs on a number of stations. Advice on every consumer subject—buying, finance, real estate, product selection—is developed in interviews with distinguished guests, among whom are Elliot Richardson; Fred Friendly, Ford Foundation radio and TV chief; Esther Peterson, consumer adviser to President Ford; and many others of similar caliber.

Starcaster — Two-minute vignettes on the universe around us—fascinating glimpses into astronomy, prepared by experts at the NY Hayden Planetarium.

BFA has material for the news slots, in the form of weekly, in-depth commentary by news analysts, in the U.S. and in a number of foreign countries. This material is intended to be supplemental to regular news coverage, moving many political topics into a wider perspective.

BFA also has a number of music programs of very high quality including much jazz, classical music from international festivals, American Indian music, African music, recordings of the Big Bands of the '30s and '40s and others. Like the talk shows, the BFA music shows seem likely to supply a fresh unhackneyed quality that may be welcome in many program assemblies.

As we go to press, we learn that the FCC has extended from May 1st, 1977 to June 1st, 1977 the deadline for compliance with the new FM-AM non-duplication rules (see *BM/E*, February).

continued on page 22

Broadcast Financing?

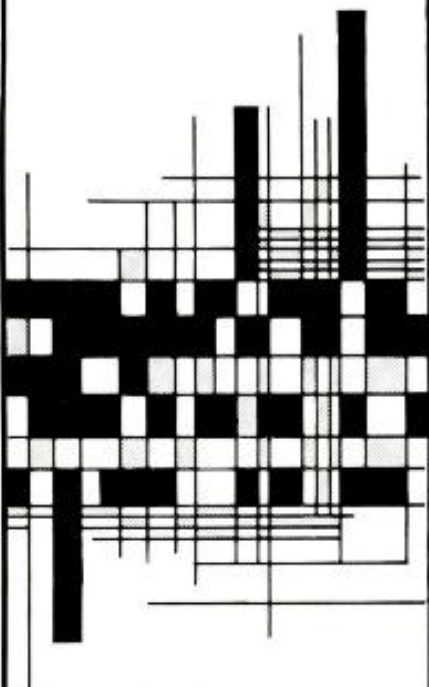

Heller-Oak knows the Industry's needs.

- Loans
- Leases
- Acquisitions
- Refinancing
- Discounting Seller Notes

Heller-Oak has built its reputation in communications financing on these clear-cut principles:

- No equity participation
- No commitment or investigation fee
- Each transaction is an "Original" structured to your specific needs

From \$200,000 to \$20,000,000 we would like to see your deal. If there is a way to put it together, we would like to work with you to produce the best financing possible.

Call or Write:

David M. Robbin or Loren N. Young



Communications Finance Corp.

105 W. Adams Street
Chicago, Illinois 60690
Telephone: 312/346-2300

A joint venture of
Walter E. Heller International Corporation
and Oak Industries Inc.

Circle 118 on Reader Service Card

BM/E's Program Marketplace

Syndicators For Radio

Drake-Chenault Enterprises, Inc.

8399 Topanga Canyon Blvd.,
Canoga Park, CA, 91304 Tel: 213-
883-7400

THE PROGRAMMING/MANAGEMENT TEAM of Bill Drake and Gene Chenault started developing their syndicated programming for automated stations in 1967. The business has grown steadily through the decade: Drake-Chenault is now programming some 200 stations across the country, probably the largest number for any current syndicator.

Both had extensive experience in radio before they joined forces. Bill Drake had been a program director and expert on rock music for several stations. Gene Chenault had been focused more on station management.

With this combination of skills, Drake-Chenault set out to supply radio stations with across-the-board programming and operations plans. As the business grew, they added additional experts in sales, marketing, promotion, engineering, as well as programming, to help in giving stations around-the-clock sound, plus sales, promotion and technical guidelines.

Art Astor, executive vice president and general manager, was formerly vice president and general manager of KDAY in Los Angeles, and earlier general sales manager of KHJ-AM and FM, among a number of other executive spots in broadcasting.

Bert Kleinman, executive vice president for programming, had been program director of WPLJ in New York, and before that, on the programming staff of WABC in New York, program director of WRFM, and in programming for WNEW and WINS, all in New York.

Lee Bayley is vice president for programming and station relations. His last previous post was vice president for programming of KAKC in Tulsa; he also wrote, produced and starred in TV programs on KOTV.

A Drake-Chenault team begins by working with station personnel to research and analyze the market. Once the station's needs are known, format recommendations are made. Then it's up to station management to decide on the programming and sales directions.

"Our product is more than just tape reels," says Bert Kleinman. "It's all the additional programming help and advice to make a station successful." With the receipt of a Drake-Chenault format, jingles, promos and ID's, the station has the ingredients for a complete round-the-clock sound.

After the format is on the air, Drake-Chenault supplies constant critiques of the station's air sound; advice and ideas on promotion; evaluations of competitive changes. Mr. Astor adds, "We know that these additional services are also important in the total success of the station."

Drake-Chenault views flexibility as one of the most important features of their programming. Every format can be adapted to particular audience needs and varying commercial loads. As Mr. Kleinman explains, "Drake-Chenault formats are designed to be . . . custom mixed to meet the competitive challenges of any market. We feel that an automated station can have the flexibility to be fully competitive with live operations."

To help fill a station's individual needs, an IBM 360 computer is used to structure the music formats. These formats can then be adapted, again through the computer, for a particular market. Finally, if, as time goes on, the market situation changes, Drake-Chenault can help the station meet the challenge with new and different music and format variations.

Although Drake-Chenault provides the station with a complete and individualized music sound, the organization emphasizes that success depends on the station staff itself. The staff must work together with a competitive spirit or the station will fail to reach its potential. "We believe that success is caused by a number of factors," says Mr. Kleinman. "It's a combination of good programming, effective advertising and promotion and a first rate staff to make it all come together."

Drake-Chenault puts the priorities as follows: maintaining high technical standards; recording and producing commercials, news, weather, public service announcements, and promotions; properly combining these elements with the format elements in the automation equipment; developing a strong sales force to bring in the desired revenue; developing an effective advertising plan to promote the station through such things as billboards, television, bus cards, etc.

The music: automation does it better

Drake-Chenault believes their "more music/controlled personality" approach demands a consistency and control which can be achieved better with automated operation than with so-called "live" operation. New

continued on page 24

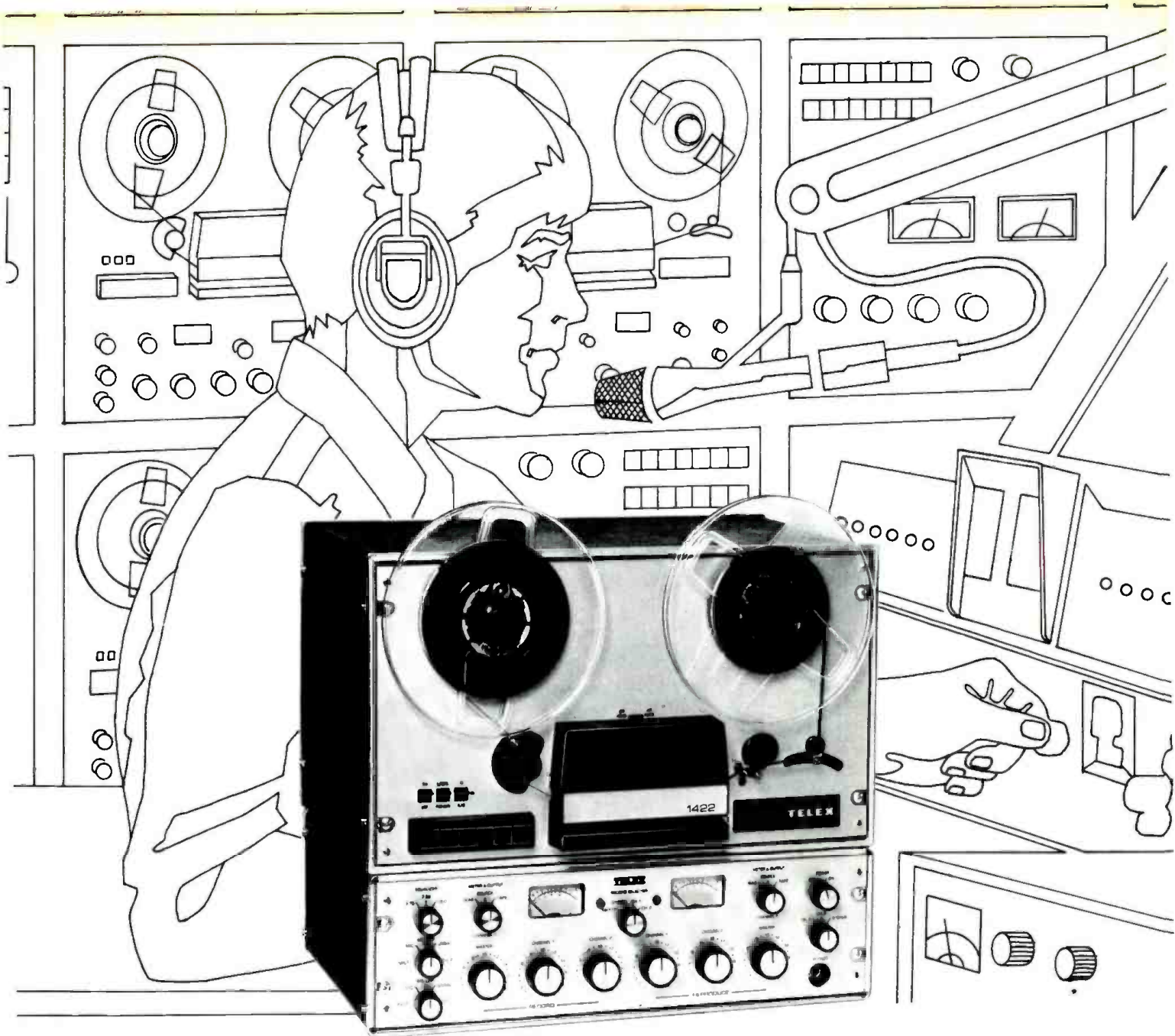

Old-New Reel Time Recorder

Telex/Magnecord series 1400 broadcast quality recorder/reproducer. An old name that spells reliability. A new design for today's state of the art.

The Old. Telex/Magnecord products are still made in the USA so parts and service are always available. The series 1400 is still built on a solid die cast aluminum main frame for reliable operation around the clock. It's still available in full, half and quarter track configurations, has fail safe differential brakes and accepts 8 1/4 inch reels. It also still comes with three motors—but then, that's touching on the new.

The New. A brushless d.c. servo drive with a crystal oscillator control reference so accurate it virtually eliminates program timing errors. New, three speeds: 3 3/4 - 7 1/2 - 15 ips. New catenary head block for straight tape loading, the con-

venience of one hand cueing and the bi-level illumination of push button controls. New DTL logic controls eliminate EMI and provide fast, spill proof tape handling gentle enough for half mil tape. And new electronics, clean to 60 dB S/N at all speeds.

If you're looking for a real time, reel recorder with old name reliability but designed for today's demands, you'll find it in the Telex/Magnecord series 1400. For complete information please write:

PRODUCTS OF SOUND RESEARCH
TELEX[®]
 COMMUNICATIONS, INC.

9600 ALDRICH AVE. SO. • MINNEAPOLIS, MINN. 55420 U.S.A.
 Europe: 22, rue de la Legion-d'Honneur, 93200 St. Denis, France
 Canada: Telak Electronics, Ltd., Scarborough, Ontario

Circle 119 on Reader Service Card



Color, Action, Hands-free Mobility

Combine the finest omnidirectional dynamic boom mike with an equally high performance binaural headphone and you have the superior Sportscaster headset...the Telex CS-90. For live broadcasts, from the station or on remotes, with cue and program monitoring and hands-free convenience. The audience hears every word, clearly, crisply, with crowd noise for background color and atmosphere. Circumaural ear cushions screen out noise in the immediate area so that special acoustic facilities are unnecessary. Supplied with convenient in-line, mike-muting "push-to-cough" switch. The Sportscaster headset. Color, action and hands-free mobility. For complete information please write:

PRODUCTS OF SOUND RESEARCH
TELEX[®]
COMMUNICATIONS, INC.

9600 ALDRICH AVENUE SOUTH
MINNEAPOLIS, MINN. 55420 U.S.A.
Europe: 22, rue de la Legion—d'Honneur,
93200 St. Denis, France
Canada: Telak Electronics, Ltd., Scarborough, Ontario
Circle 121 on Reader Service Card

Radio Programming

Drake-Chenault programming developments have led to almost limitless flexibility. Music mix can be varied from daypart to daypart. The tempos can change and so can type of music.

Further, the formats allow for any commercial load a station finds desirable. The following are the formats now available from Drake-Chenault:

Contempo 300—Modern Adult Contemporary, designed to appeal to the 18-49 demographics that national advertisers are especially eager to reach.

Beautiful Music+—An approach to beautiful music that incorporates Drake-Chenault's quality control and flexibility. The music mix of Beautiful Music+ can be varied to provide the exact demographic balance to meet a station's needs.

Great American Country—This is a contemporary, uncluttered "more music" approach to country music, and is extremely popular.

XT-40—XT-40 is the very well known Bill Drake approach to rock. Fast paced, XT-40 has a "clean" sound combining the hits of today with oldies going back to the mid-60's.

XT-100—To meet the needs of stations with expanded playlists, Drake-Chenault has created a new approach to AOR (album oriented rock) called XT-100. It is a "young adult" format and like the others, can be "custom blended" to meet the special requirements of each individual market.

SuperSoul — Drake-Chenault's SuperSoul is a modern Black radio format programmed for large-audience appeal.

Classic Gold—Classic Gold is Drake-Chenault's "all oldies all the time" format. Although Classic Gold was originally designed for specialized major market audiences, it can also be programmed as a weekend special feature by small or medium market stations.

The three C's

Drake-Chenault has a philosophy on the differences in approach between automated and so-called "live" stations. Most people neither know nor care whether the station they listen to is automated or "live." The listener either likes what he hears or doesn't. In fact, most "live" radio stations are about 90% records, recorded commercials and other elements which can't really be thought of as "live."

As opposed to "live," says Drake-Chenault, one thing an automated station can sound like is **ALIVE**. That sound of **ALIVE**-ness,

immediacy and a wide variety of human qualities, lets audiences know a station is people . . . involved people concerned with their community.

Drake-Chenault has dubbed the principal programming values they aim for in an automated station, "The 3 C's." These are Consistency, Cohesion and Concern.

Consistency—Consistency is an hour-to-hour uniformity of sound which makes a radio station unique and distinctive. In this, an automated station with a well-designed format has a major advantage over "live" competitors. If the format has certain consistent elements of style, certain things will happen each and every hour on the station. The music flow will maintain a consistency almost impossible to achieve with a "live" operation.

Cohesion—If the air sound is unified and makes sense to a station's audience . . . that's cohesion. No one should be able to perceive any difference between the syndicated programming and everything else that happens on the air.

The station's production department should maintain the highest standards. Commercials, as well as the other basic elements on the station, should reflect the same high quality as the format.

Concern—The way in which the station serves the public creates the personality of the station. The things done, in addition to the music played, will tell the audience what kind of people make up a station. All news, weather, PSAs, contests, and promotions should be selected and designed to serve the public and create the favorable image a station wishes to convey. Radio is the most intimate of all the mass media. The audience is very sensitive to the image projected.

Other programs

Drake-Chenault also produces a number of special programs. Among the most successful are: "The History Of Rock & Roll," a legendary 50-hour program which ran on scores of stations. It is being completely revised for spring 1977 release. Also available are "The Golden Years of Rock," "Top 100 of the 60's" and "The Golden Years of Country."

Syndication in 1977: the outlook

Drake-Chenault's expectations for 1977 are summed up by Art Astor: "We anticipate that 1977 will be the biggest year so far for syndicated programs and formats for automation. The emphasis on professional programming coupled with economics and improved technology will increase the percentage of automated stations across the country during the next year." **BM/E**

Maximum Sound Performance In Harris' AM Transmitters. High Technology Working for You.

For the loudest sound and highest efficiencies in AM transmitters, Harris offers the new MW-A series.

Now included in the MW-1A, 1 kw, MW-5A, 5kW, and MW-50A, 50kW, transmitters is a built-in audio processing circuit.

This circuit is designed to increase loudness up to 3dB. When adjusted to

station format, small modulation peaks, which hold the average level down, are reduced, allowing the larger and more powerful levels of the audio signal to modulate the transmitter at the maximum limit.

The new MW-A series of transmitters with PSM*, MW-1A, and PDM*, MW-5A and MW-50A, offer other superior features...

- PA efficiency approaching 90%
- 125% positive peak modulation
- Low distortion
- Excellent transient response
- Wide frequency response

For complete information on the world's number one AM transmitters, write: Harris Corporation, Broadcast Products Division, Quincy, Illinois 62301.

*Patented



**MW-1A, 100%
solid-state one
kilowatt
transmitter**



HARRIS
COMMUNICATIONS AND
INFORMATION HANDLING



**MW-50A, fifty
kilowatt
transmitter**



**MW-5A, five
kilowatt
transmitter**

Circle 120 on Reader Service Card

TELEVISION

PROGRAMMING & PRODUCTION FOR PROFIT

KPIX: "Evening—The MTWTF Show"

A local "Strip Show" goes national and may portend a whole new way of spending and making money.

ON THE NIGHT OF August 9, 1976, San Francisco's TV audience got its first look at a new prime time access period program that may go a long way towards fulfilling the promise the FCC saw four years earlier when it issued the PTAR. Unlike many PTAR inspired programs, it was not a game or animal show, or for that matter, a sanctimonious public affairs program born of an overburdened conscience and at considerable loss of revenue to the station.

It was the first edition of "Evening—The MTWTF Show," born of innovative thinking, confidence in a creative staff and a concept based on the new EFP equipment capability. Like any first rate television show, it is difficult to do it justice with only words but essentially the program is a briskly paced magazine format show, breezy and fresh—fresh 260 evenings a year. Bill Hillier, program director at KPIX and executive producer of "Evening . . ." reminds you that the magazine format is not patterned after Time and Newsweek but from the mold of New York Magazine, New West and Rolling Stone.

KPIX moved to the new show despite the fact that its "5 on 5" string of game shows in this time period was still doing well in the ratings. But a decline in HUT levels and the erosion of the audience to independent television station offerings in access time had Hillier concerned. Moreover, the cost of syndicated products was on the rise.

Hillier decided, and convinced station management, that the money being spent on syndicated products could be put to better use. "When we were asking ourselves what to do," said Hillier, "I thought if I took that money and put it into local production, I could do a better show than I could buy."

The show costs KPIX about \$2000 per edition which is just slightly less than it was paying for the syndicated product but it is much more rewarding.

The show begins with a very lively animated lead-in that has a pretty colored ribbon lightly winding and floating its way through graphic portrayals of "San Francisco-quaint" buildings and locales against a clear sky-blue background. The music is light and cheerful. The lead-in sets a tone and level of expectation which the show itself does not disappoint.

The show consists of three segments, all produced on location (indoors and out-), completely on EFP equipment. According to Shelly Fay, producer of "Evening . . ." the show is "based around" the use of three Ikegami HL-37 mini-cams. The fact that the show is done on videotape is part of its feel and its feel is all important. "It just has a look to it," said Fay, "that you wouldn't get with film; it gives us this *feeling*."

To a great extent, "feeling" is what "Evening . . ." is about. The segments are each 7 minutes long. Each night there is an "Evening Person," a profile of a celebrity or local character; "Evening Story," about a local issue, event or human interest piece, and several short (2 minutes, more or less) "Evening Tips," each hosted by a different "Evening Tipster."

The tips are consumer items, health, exercise, the "best . . ." something, like the best children's slide in San Francisco or best ice cream or best pasta.

The program is anchored by two hosts, Steve Fox and Jan Yanehiro; both are attractive young personalities with special talents that are reflected in the stories assigned to them.

"Evening . . ." is not a part of the news operation but a separate entity under the programming department. The decision to be autonomous was a conscious one. It reduced potential conflicts. Hillier points out, "We don't share equipment, people or anything with news. We chose not to do the show using the 'news cookiecutter.'"

The technical operation of the program centers around field producers who are responsible for the production of each segment. The show has two full time field producers, Scott Gibbs

and Jim Arnold. Each field producer has a field team consisting of an associate producer, a production assistant and a full-time editor. The field producer does the camera work and supervises the project from "concept through completion."

Each field team is assigned a van, complete with all necessary production equipment and designed to be comfortable during the full day spent in the field. There is no maintenance facility or microwave, live capability, in the vans, and no film equipment is used. "This is a purposeful experiment," points out Fay, and once the premise is set that the segments will be taped on location, there is no turning back. Though the team may yearn sometimes to do a piece in the studio or use film or go live, it is not done. "Evening . . ." is as much EFP equipment as it is anything else. The way the show is done is part of its chemistry. The locations are also important but as Fay said, there must be a reason to be on that location; it must be important to the story.

Used with the Ikegami are Sony VO-3800 cassette recorders. The show is edited on helical scan equipment and editing control is accomplished with a Datatron 5050. The crew, which prior to "Evening . . ." had only film experience or some very minor mini-cam experience, has adjusted to the equipment very nicely. The show is highly produced and sound is not neglected. Music and narration play an important part and a Teac six-channel recorder with EQ helps out.

"It's a systems show," said Fay. About six weeks out, the staff and Fay begin going over the ideas that have been generated. Ideas are no problem, they come from the show's staff, the public, a knowledge of what celebrities and music groups are scheduled to be in town and a host of other sources. Fay goes over this material carefully and begins to select which ideas are the most promising. "My function is content and programming," said Fay. "You have to program this show as you would a full television day schedule." The "mix" within the program and for the entire week is very carefully considered. There are ten major segments a week and anywhere from ten to twenty "tips." "Generally you try to mix a five day week, going for a good mix of celebrities from television or film, music groups or stars, media type stories, nature, animals, and maybe an investigative piece." By three weeks out, the staff must know very closely what the projected week's programs will look like in order to buy ads or advise TV Guide.

Planning can get very tricky that far out given the nature of the show. Fay

continued on page 28

Maximum Signal Performance In Harris' FM Transmitters with the MS-15 Exciter... for the Sound of the Century!

There's no doubt about it, your listeners will hear the difference with the new Harris 'K' line of FM transmitters featuring the MS-15 solid-state exciter, employing Digitally Synthesized Modulation (DSM)* and overshoot compensation. These advanced design techniques offer higher stereo separation, and increased loudness with no degradation of audio quality.

DSM affords the ultimate in stereo and SCA performance,

with 40 dB or better separation, 30 Hz through 15 kHz.

Modulation of the 19 kHz pilot and crosstalk into the subchannel are eliminated with this technique.

The new Dynamic Transient Response filter (DTR) allows no greater than 2% overshoot. Thus, a 2 to 6 dB increase in loudness can be achieved while maintaining excellent transient response, high stereo separation, low crosstalk and low intermodulation distortion.

For the clearest, loudest sound around, write for information on the new Harris FM transmitters with the MS-15 exciter to: Harris Corporation, Broadcast Products Division, Quincy, Illinois 62301.

*Patent applied for



HARRIS
COMMUNICATIONS AND
INFORMATION HANDLING



Circle 122 on Reader Service Card

Now! Remote transmitter control

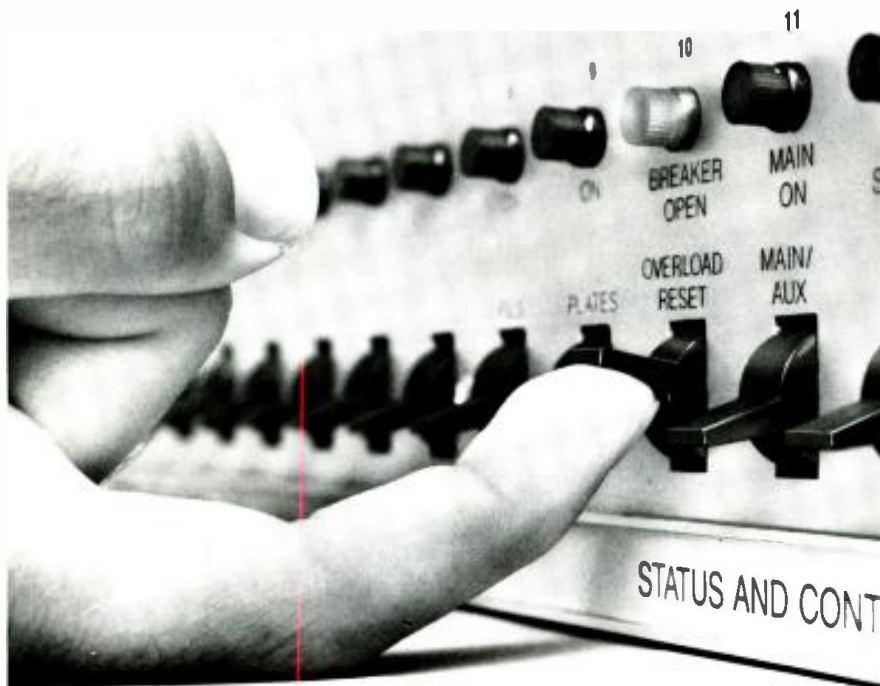

is this simple.

Now there's an all digital system that gives you direct, positive on/off control and status monitoring of remote AM, FM and TV transmitters. We call it the X-14, and there's nothing else like it.

Fourteen toggle switches give you direct on/off control of up to 14 different functions like: filament voltage, plate voltage, main power, overload reset, tower lights and program source selection. No longer do you have to dial them in one-at-a-time.

In addition, fourteen status channels, each with its own, independent LED indicator, monitor such go/no-go functions and/or alarms as: power, voltages, temperatures, intrusion, VSWR and tower lights. You see a complete display of status and alarms, at-a-glance.

Besides all this, the X-14 is an economical way to add capability to an existing analog remote control system. It meets the FCC control failsafe requirements, and gives you a fully digital command system as

backup to your analog operation. So, the direct control switches on the X-14 can be used for critical "key" functions while, at the same time, you're using the analog system to read other transmitter parameters. With our optional Line Multiplex Filter, both the X-14 and your analog system will operate on the same phone line.

Exceptional data integrity is another advantage of the X-14. Both control and status information are updated every 400 MS, and a unique "double check" logic system virtually eliminates data errors. There are also fewer operator errors because there's no dialing and knob twisting. Each switch is labeled for a specific function. The X-14 is also ATS-compatible.

The X-14 is just one of the many new ways TFT is applying digital techniques to simplify and improve broadcasting remote control. For a demonstration, call or write. In Canada: Orange County Associates, Winnipeg, Manitoba.

TV Programming

cannot always be certain that a prospective piece will turn out well. A personality that seemed interesting may be dull, a technical problem may arise in the field, or any one of a thousand things can go wrong. That it works as well as it does has almost everyone on the program cautiously amazed. "If I were to be asked to do a show like this again, say ten years from now," said Fay, "I'd ask for a computer, a systems analyst and somebody from a Ford Motor Company assembly line plant to help work out all the complexities."

The actual segments are shot about a week in advance of air time. A day is allowed for recording and another day for editing. At the beginning, more time was allotted but that turned out to be uneconomical. There is leeway, but not much. The ability to stay on schedule is largely due to the reliability of the equipment. All of "Evening's . . ." equipment is maintained by one technician from the station's engineering department. The station's other regular technicians only get involved when there is an emergency and when the show is dubbed up to quad and the final mix is done.

Though the show is restricted to only 3 commercial minutes, it is pulling its weight in the market and demand from advertisers far outstrips availabilities. The restrictions on commercial time is also purposeful and plays a part in maintaining the "atmosphere" of the show.

As mentioned earlier, "Evening . . ." is far more than a local strip show. Group-W plans to carry it during access time on each of its 5 stations come October. And there begins a whole new experiment. Each station, it is hoped, will produce its own segments for the "Evening . . ." show to be combined with the San Francisco output. Not only will this approach help to localize the program in the various cities, but Fay thinks it will raise the overall quality of the content. The San Francisco team will have a lighter and therefore more selective production plan and the possibilities of the cross-cultural exchange between five major American cities is exciting.

The show is doing well and growing in the ratings, averaging a 10.3 in the January book. If the Group-W experiment succeeds, the show may be offered for syndication and George Back, v.p. of sales for Group-W, is considering what he calls the "30-minus" approach: the purchasing stations will be able to use all of the "Evening . . ." segments or any portion, rounding out the 30 minutes with its own production.

BM/E

TFT TIME AND FREQUENCY TECHNOLOGY, INC.
3000 OLCOTT STREET, SANTA CLARA, CA 95051 (408) 246-6365 TWX No. 910-338-0584

Circle 123 on Reader Service Card

Maximum Color Performance In Harris TV Transmitters with TSB. Because The Best is Getting Even Better!

Now--Maximum color performance...fewer adjustments...in the new line of Harris IF (Intermediate Frequency) Modulated TV transmitters, featuring the MCP solid-state visual exciter with TSB (Transversal SideBand) filter.

The latest state-of-the-art design techniques in the new visual exciter/modulator

include the TSB filter, which requires no group delay correction or tuning adjustments...ever! Only 1½ square inches in size, the filter is mounted on a PC board in the visual exciter. Harris transmitters are also ready for ATS.

For all this, plus great stability, reliability, and the truest color quality, check out

the new line of Harris TV transmitters.

For complete information write: Harris Corporation, Broadcast Products Division, Quincy, Illinois 62301.



HARRIS
COMMUNICATIONS AND
INFORMATION HANDLING



Harris' new TSB filter...actual size

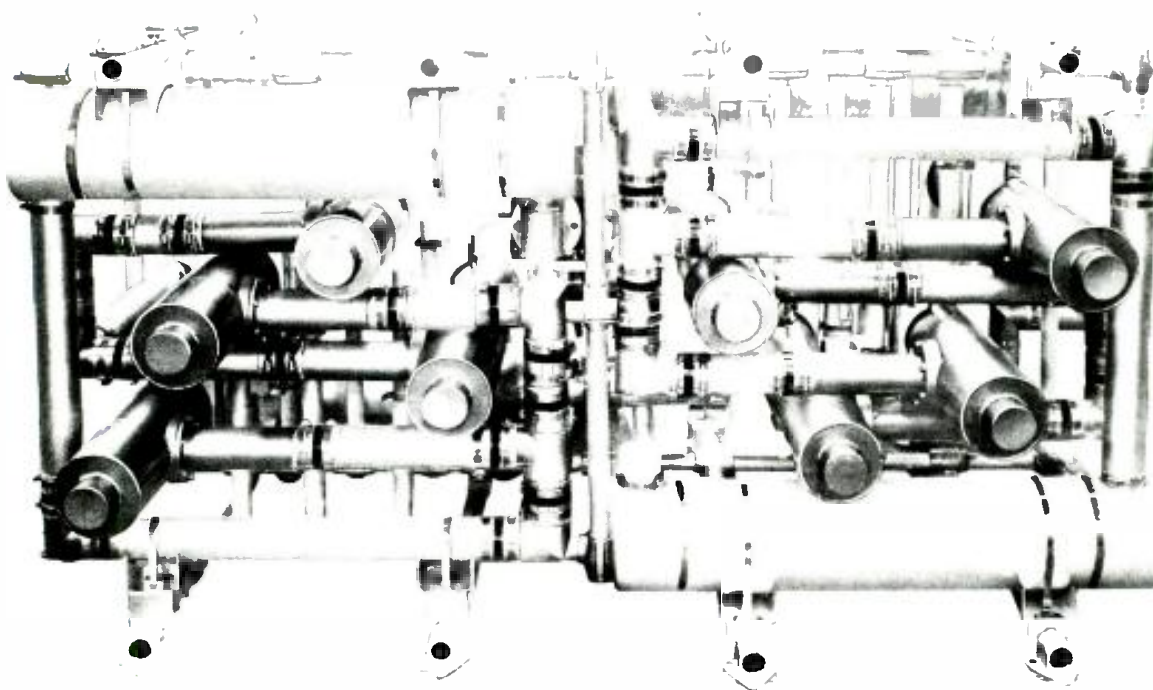

Conventional VSB filter... over 280 cu. ft.

Circle 124 on Reader Service Card

TK-760: the new color camera with

Big value, small package.

The new TK-760 is a fine studio camera in a compact configuration. It produces the picture quality and colorimetry for interface with other cameras, resulting in outstanding production flexibility.

This 45-pound field camera is at home outside the studio, too. It is easily transported, flexible and self-contained—ready to produce remote pictures without sacrificing any of its automatic features or compromising its picture quality. AC power input through a power cord yields video output through a coaxial cable, without a CCU.

The TK-760 CCU features automatic cable equalization (ACE). It adjusts for cable lengths from 0 to 1000 feet. Cable testing and mechanical compensation are eliminated. Time and money are saved, and consistent picture quality is assured. With ACE, multi-CCU positioning in busy locations becomes a reality. Just plug in the TK-760 camera to the pre-located CCU, and you're on-air immediately.

Long-term camera stability assures fast setup time. The compact CCU size (8½" x 10½" x 3¾") lets you run more than one camera from the CCU module, with multiple CCUs mounted side-by-side.



Impressive, proved features.

These quality camera features, and the TK-760 format, are based on the technology of the performance-proved RCA TK-76 electronic journalism camera:

- Prism optics
- Bias light; minimizes lag at low light levels
- Built-in sync generator; genlocks to black burst or composite signal
- Vertical and horizontal contour enhancement with comb filter and coring
- Chroma keyer option; installed as an integral part of the camera
- T-frame construction; maintains optical alignment
- Shock-mounted optical system; maintains registration, reduces microphonics
- Automatic iris control
- Automatic white balance control
- Automatic flare control (black level)
- Video level indicator in viewfinder; senses peak white
- +9 dB video gain switch for extremely low light levels
- Accommodates a variety of lenses
- Fast warmup—useable picture in 5 to 7 sec.
- Built-in filter wheel

Big view, handy controls.

The new TK-760 boasts a 5" diagonal view finder for effective picture composition. And well-placed pushbutton controls afford

maximum camera operator convenience.

"must-see" value.

You pay much less than you'd expect for all the quality and the many convenience features you get in the TK-760.

If ever there was a "must-see" camera value, it's the new TK-760.

So get your hands on one soon. Your RCA Representative will arrange that.

Get your hands on the new TK-760 at NAB. It's one more of The Dependables.

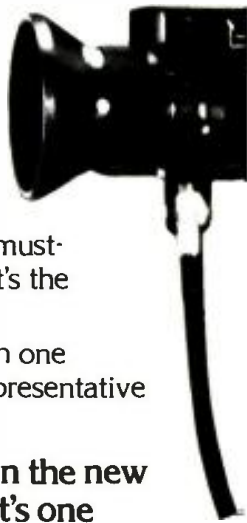

RCA



use-it-anywhere the surprising price

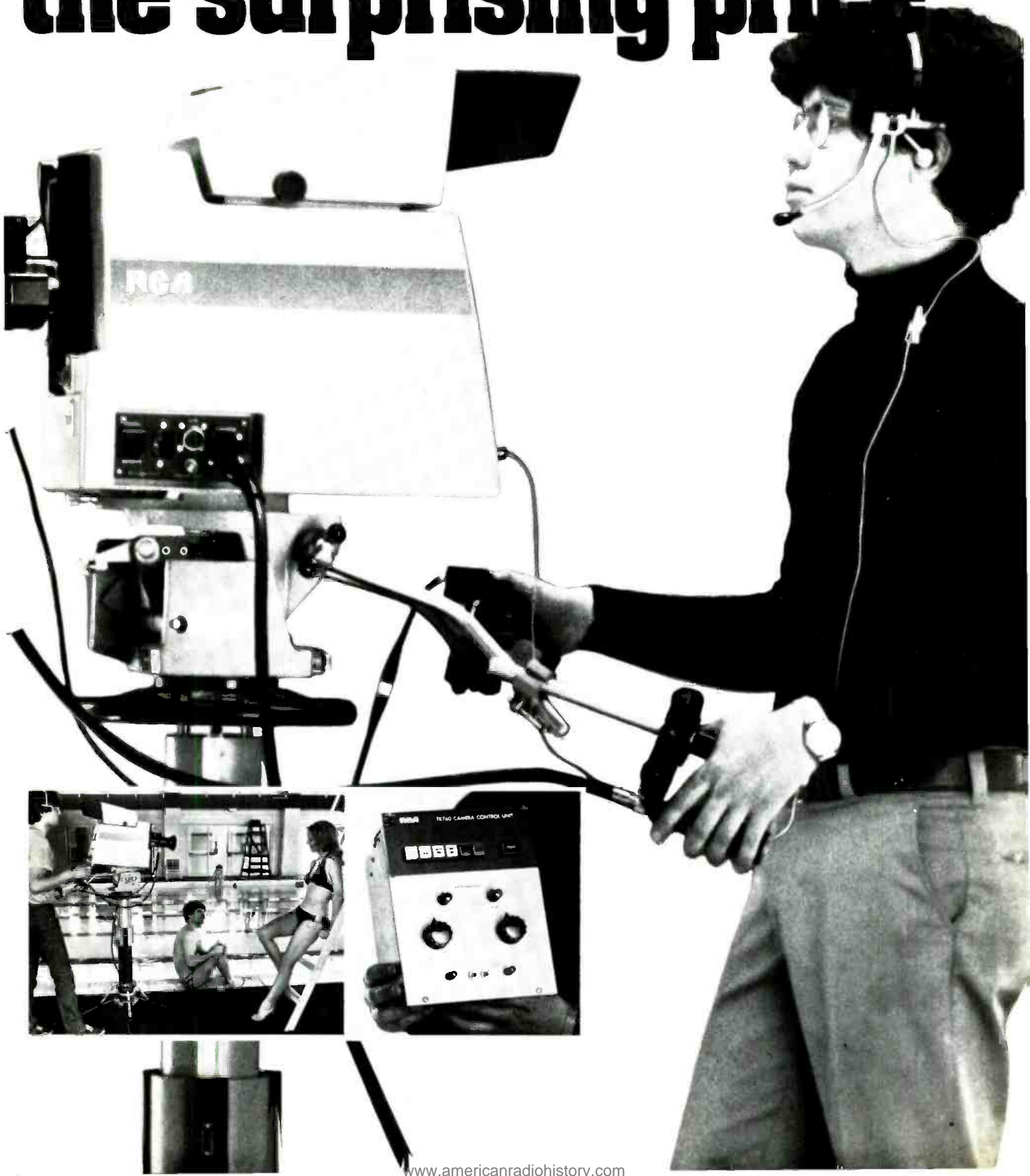

AUTO-EDIT

new for
R-MOD

No Cost Editing for Your Quad VTR

- Another FREE feature with R-MOD
- Extremely easy to operate
- Frame accurate assembly edits
- Provides for reliable remote editing
- No expensive time code required

R-MOD Extends Life and Adds Intelligence for Your Quads

R-MOD gives your quads the tape handling and other intelligent features of the latest quads at a low price.

R-MOD is the intelligent alternative to a new quad.

Now Available for

VR-1200 TR-22

VR-2000 TR-70

AVR-2 TR-600

new



VIDEO TAPE ADDRESSOR

- Off line high speed time code writer
- Writes both control and cue
- Saves VTR time
- Saves VTR heads
- Cleans and rewinds tape



VIDEO TAPE EVALUATOR

- Cleans and evaluates tape
- Pays for itself in a few months
- Evaluates tape 16 times faster
- Saves VTR time
- Times tape length—locates splice

RECORTEC, INC.

777 Palomar Ave., Sunnyvale, CA 94086
(408) 735-8821 TWX 910 339 9367

as seen at N.A.B.
and MONTREUX

Circle 125 on Reader Service Card

New One-Inch VTR Formats Go Into Action

Production houses are quick to size up
in to move to one-inch professional videotape

...TION, evaluation, and reflection
there isn't any compatibility of
professional quality videotape
ree contenders are selling.

ports over 140 BCN units sold and
n Europe and Australia.* The first
omer in the U.S., a training de-
ell, was in the process of accepting
ort was being prepared.

corp. has had 25 production models of the
000 delivered to the U.S. for sale in this country.
CBS Television City, Hollywood, has traded in its three
prototype units (see *BM/E*, January, p. 62) for 15 pro-
duction models—five for use in dramatic productions,
five to go into a new editing system (more on this later)
and five to replace some tired recorders now used for
delayed broadcasts. NBC Television network has two
units in its hands now with options to take delivery on
five. Fireman's Fund training group in San Francisco
took delivery on two units in January.

Ampex began delivering the VPR-1 in December of
1976. TV station KHQ-TV, Spokane, Washington, is
one of the first customers. So are CTP, Inc., of Salt Lake
City, and Vidtronic, Los Angeles. The University of
California in Davis and Gulf Oil in Houston are others.
The company claims an order backlog of \$5 million from
customers in the U.S., Canada, Europe and the Far East.

BM/E has not talked with all of the owners of this new
one-inch equipment but we have had extended interviews
with several. The experiences to date of users, regardless
of the system purchased are all positive. Customers like
the quality, the convenience of the small sized units, the
low initial cost and the operating savings they expect to
cash in on. There are also other features, such as editing
simplicity (Ampex, Sony) and broadcastable slow-
motion (Ampex), that impresses some users, but more on
that later.

The unqualified praise for these new videotape record-
ers which we are now able to report* signals to us the
beginning of a new era—an era in which one-inch VTRs
will take their place side by side with quad. Within the
TV studio or production center they will not replace quad
but share part of the load—not as a mastering machine
for those no-cost-spared jobs, but certainly as a logical
choice when costs must be held in line (one hour of
one-inch videotape is 75% less). The one-inch profes-
sionals will get into the field as quads were never able to
do—rack- or dolly-mounted console units in vans and

trucks; handcarried portables on streets, sidewalks, the
office and home. The one-inch professional VTR will go
to some of the places where only film cameras have
traveled before. In fact, the 70 lbs. of gear minimum
(camera and portable VTR) weigh about the same as a
35mm film camera loaded and ready to shoot. Of course
an umbilical cord between the TV camera and recorder is
necessary. But the one-inch VTR/camera combo does
become a new electronic tool for cinematographers. The
shooting style is the same for the two media—classical
single camera technique. A camera will be tied to its own
VTR and everything going through the lens will be re-
corded for later editing.

Just how fast will the new one-inchers move in? Won't
the lack of compatibility be a real deterrent? If you can
believe the sales figures boasted by manufacturers to
date, we will be seeing plenty of these new units within
the industry in the coming year. Just how many per
month will be throttled by the capability of the produc-
tion line.

The new recorders will be used for production pur-
poses primarily and less for broadcast playback—except
for those German organizations which have standardized
around BCN for on-air playback. A standardized format
for universal tape interchange in the U.S. is some time
away. We'll have to see how well the SMPTE stand-
ardization committees fare (*BM/E*, March, p. 82). The
lack of standards will be a deterrent to some prospects
but there are more than enough eager buyers right now to
gobble up every machine that can be produced during
this next year. Simple economics make it so. Bosch
Fernseh people have made some calculations which
show that if you use a BCN 3000 hours a year, it will
have paid for itself in the first nine months! We don't
know all of the factors that were considered but com-
pared to quad, tape cost is less, tape containers cost less,
tape shipping costs are less, head repair or replacement is
considerably less, regular maintenance is calculated to be
less, power consumption/air conditioning is less, amorti-
zation of capital costs are less. You might try your own
calculations.

NBC To Do Docu-Drama

The NBC Television Network expects to take advan-
tage of the one-inch recorder in producing programs that
can best be described as docu-dramas. That is, says
Robert (Shad) Northshield, producer, they are non-
fictional true stories but recreated through the use of
professional actors.

One major objective is to come in with quality pro-
gramming that is going to cost a lot less. Right now NBC
buys much of such material from independent producers

*Among the BCN countries are: Sudewest Funk (SWF), Baden-Baden.
Sender Freies Berlin (SFB), Berlin; Dansk Radio, Denmark; ORF (Austrian
Broad.), Vienna; 3rd Network, France; and Channel 7, Perth, Australia.

*Last month, for example, in reporting the SMPTE Winter TV Conference,
none of the six users on the Future Of One-Inch VTRs had yet committed
themselves.

One-Inch VTR Formats



NBC engineers Bob Butler, left, and Frank Fleming, right, check out producer Shad Northshield on operating features of Sony BVH-1000.

who shoot on film. The problem is costs have been running away. Northshield expects through the use of videotape techniques to save money. If costs are indeed lowered, as he expects, he will force outside producers to follow suit. Reduced costs will come about because tape is less costly than film and time on location will be less. Since each scene can be monitored immediately, directors know what they have satisfactorily taped.

The plan at NBC is to build a van that can go out on location ideally equipped to shoot as quickly as possible. The engineering department is building a truck that will carry two Sony BVH-1000s (sometimes referred to as the Omega) plus a ¾-U matic recorder (for quick daily edits in the field). Two TK-76 cameras will be used. A 12-channel audio recorder makes up the rest of the equipment complement. There will be no switcher in the van. All action will be shot single camera. The truck will carry six people—cameramen, videotape engineers,

Slow Motion, Still Frame and Easy Editing Are The Hallmarks Of The VPR

"The VPR-1 is the first helical videotape recorder that is capable of broadcasting slow-motion and still-frame pictures of professional quality," said Donald V. Kleffman, vice president-general manager of the Ampex audio-video systems division. "And it is the first video machine that makes tape editing as easy as film editing."

With its exclusive Automatic Scan Tracking (AST) system, Ampex says the VPR-1 eliminates the problem of tracking and interchange—the classical shortcoming of helical VTRs—while offering fully automated tracking, still-framing, 1/5 speed, slow motion, and manual frame-by-frame "jogging" for simplified editing.

The VPR-1 produces high-band color pictures in the fully compatible Ampex 1-inch format, the same format used in over 30,000 VTRs worldwide. The VPR-10, a complementary field production recorder, permits the user to go wherever the action is.

The VPR-1 is available in any configuration from rack-mount to full studio console, making it adaptable for any application from straightforward recording and playback to sophisticated teleproduction or broadcasting. Kleffman boasts, "VPR-1 with Automatic Scan Tracking is truly the most significant development in helical recording since the first practical helical scan machine was introduced."

soundman, director, etc. lights, props, etc.

Northshield says the low." He will shoot to a and hopes to do all shooting. Nonetheless, his crew may be four weeks.

The first docu-drama to be Buffalo Creek disaster. The setting is Virginia, where a dam breaks into a lawyer who represents survivors seeking settlement. At least 125 people will camera at some time or another so it is a second docu-drama planned firmly at this a crucial civil rights event that caught national years ago—and changed the course of history. docu-dramas will air in the '77-78 fall season. Each run two hours.

NBC is not exactly plying new ground in this vein since it has produced children's programs in the past using two-inch quad portables. Northshield comes from a news background and is familiar with electronic cinematography. He claims to know little technically about the one-inch recorders but is impressed with two features of the BVH-1000: the high quality picture it produces and the ease of editing with it. "Movieola-like" editing capability is cited as a real plus. Units run 30 times speed forward or reverse or can run slow motion or freeze frame. Frank Fleming, V-P of NBC's Engineering Department, rates the ability of the machine to record and pickup a portion of the vertical interval (as a result of the second sync head) as important. VTRs are now used by NBC and such use will likely be expanded.

WHQ-TV, Spokane, To Use One-Inch Portables For Commercials

WHQ-TV, Spokane, is one of the first broadcasters to get delivery of the Ampex VPR-1. Spokespersons for the station were not hesitant to describe how they intended to use these new one-inch portables—and why they bought them—but preferred not to be quoted.

Principal use at Spokane will be to produce commercials. WHQ-TV has already had a long history of success in this activity, producing upwards of 75% of all local commercials. The station has not done very much documentary work and doesn't expect to except for possibly some mini-documentary series.

In the past, for its commercial production, the station has used a TR-5 highband recorder which it can take out in a van. Traveling units are equipped with large motor generators and studio-type equipment which had been used to shoot "going down a freeway at 80 mph." The VPR-1 will simplify equipment requirements. A special hand cart or dolly has been constructed which permits one man to load the recorder inside a van or onto a pickup truck. Vehicles will use a motor generator of 500 watts capacity to run a TK-76 camera and the recorder. Although the TK-76 can't shoot as wide an angle as was possible with TK-44s, it will be the principal camera used. The freeze frame feature of the VPR-1 has given the station the ability to do the latest thing in commercials (and drama)—to close with a dramatic still shot.

The performance of the one-inch portable has im-

continued on page 36



Central Dynamics. International pacesetter in television broadcast equipment.

Video switchers.

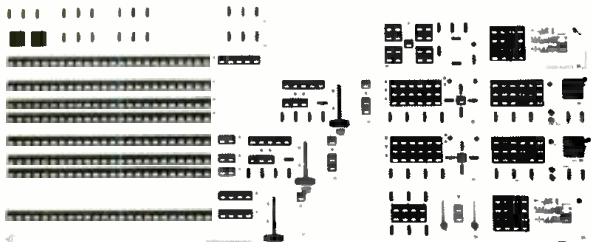

New, Super Powerful CD 480 The Smart Switcher

Revolutionary modular switchers with unprecedented production power. They outperform the largest conventional switchers, yet are extremely simple to operate. Their power and ease of operation are due to CDL's new Sequential Effects (SFX) Amplifier, which can cut, mix or wipe between two Background Sources and two separate Key Sources either individually or in any combination. Models with one or two SFX Amplifiers provide all the standard and optional features you need including Rotary & Random wipes, RGB Shadow keys, Hard and Soft Color Border wipes, Color Border keys, Quad with Color Borders, Encoded Chroma keying, Key Mask generator, and 16, 24 or 32 inputs. A variety of modular accessories will continue to keep your switcher smarter than the rest as new technology develops.



VS-10

An inexpensive broadcast quality 8-input switcher that features flexibility and ease of operation. Self-contained electronics for rapid installation in ENG and other small mobiles.

VS-14

Sophisticated enough for large studio production, yet compact and inexpensive enough for small mobiles. Soft wipes and keys—even a Downstream key—are standard. Self-contained and remote versions available.

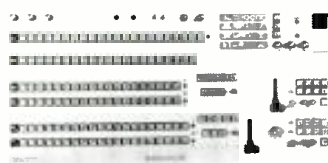

VSP-1260S

An amazing value

Now the smallest station can afford a conventional 20-input mix/effects switcher of the highest quality and reliability and get it in under 30 days! All features, including an Encoded Chroma keyer and Bordered keys, are standard (not optional, as is often the case). And the price is astonishingly affordable.

Ask about the AFM-10 Audio Mixer/Switcher—an ideal companion to the CDL VS-10 and VS-14 video production switchers.

Automation.



System 100

Computer controlled automation system for Technical Operations that communicates directly with a Business Computer System. Stores and retrieves the schedule with entry error checking, makes automatic time corrections, performs complicated audio/video switching sequences (including dissolves, fades, wipes and keys), assigns machines, verifies material, and prints the "As-Aired" log.

Master Control Switchers

Ranging from CDL's new CD 480 MC to a 2 Bus MCS-829 or a 3 Bus MCS-770. All 3 can be interfaced to System 100 Technical Automation System.

Tape editing systems.



PEC-120 Video Tape Editor

A computer editing System with easily operated control panel and CRT display for rapid and precise control of VTR's & Switcher. CDL's unique Self Learning Cueing Software Program is a new feature.



EDS-200 Video Tape Editor

A two machine Time Code microprocessor Editor that interfaces to Quad or Helical VTR's.

Also a complete line of production and TV terminal equipment, including:

- SMPTE Time Code Generators and Readers
- Video and Pulse Distribution Amplifiers
- Chroma Keyers, RGB and Encoded
- Processing Amplifiers
- Audio Video Routing Switchers
- Pulse Assignment Systems
- Machine Control Systems

Request our Short Form Catalog



CENTRAL DYNAMICS LTD

CANADA
Montreal
147 Hymus Blvd.,
Montreal, Quebec H9R 1G1
Phone—514-697-0811
TWX—610 422 3906

U.S.A.
New York City
230 Livingston Street,
Northvale, NJ 07647
Phone—201-767-1300
TWX—710 991 9753

Chicago
331 West Northwest Highway,
Palatine, IL 60067
Phone—312-991-4720
TWX—910 693 4806

Los Angeles
15130 Ventura Blvd.—Suite 307,
Sherman Oaks, CA 91403
Phone—213-789-0574
TWX—910 495 1713

Circle 126 on Reader Service Card



Dick Loudagin of KHQ-TV, Spokane, taking first VPR-1 delivered to a TV station in the U.S. out on a job.

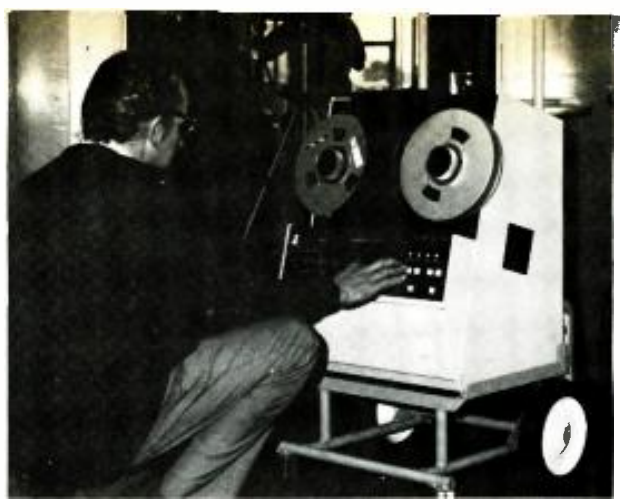

VPR-1 in operation with camera and flood light in background.

Future Plans For BCN Family Products

(Material submitted by Bob Paulson, AVP Communications, for Fernseh Div. of Bosch GMBH)

Format developer Fernseh has been aggressively promoting the virtues and capabilities of the BCN format for two years. They showed seven prototypes at Montreux in May 1975, including the portable BCN-20. Deliveries of the studio model began in December 1975. They had three models at the 1976 NAB—a fully equipped studio editing VTR had a simpler record/playback version, plus a coaxial reel battery powered portable which entered production delivery in December 1976. A portable BCN-20 and four BCN-50 studio editing VTRs worked trouble-free during the 1976 Montreal Summer Olympics as the source for all ARD German television network transmissions. Production models of all three units were prominently displayed in many exhibit booths at the 1977 NAB Convention.

In public presentations and private discussions at

both the September 1976 London IBC meeting and the SMPTE January 1977 Winter Conference, Fernseh management people have also spoken freely about their future equipment development plans. Bosch-Fernseh Division managing director Hans R. Groll is particularly aware of the fact that some potential purchasers feel the segmented format has shortcomings, i.e. editing difficulties. The company is planning several new product introductions which should eliminate most, if not all, of these negative views of BCN.

Editing on BCN. Ability to view a full picture with the tape stopped or in slow motion in either direction, but the head in motion at standard speed, is practically a mandatory requirement of editors brought up on ENG 3/4-U VTR and feature film post-production Moviola and Steenbeck editing systems. Reasons why these two diverse groups of editors need freeze frame and slow motion are completely unrelated. For instance, the ENG editor, working single system, often makes many final decisions on audio cues. However, full field viewing and edit rehearsals are necessary to show up bad jump cuts or cuts to bad facial expressions in closeups. The feature film editor, working double system, needs to see pictures in stop- and slow-motion to match edit out and in frames precisely, i.e., to make the cut exactly when the fly lands on the lady's nose, etc. regardless of audio editing decisions (which can be made separately).

Editing systems, to satisfy these two schools of editors, must display full pictures on demand. However, an editing system must do more: it must perform search and cue for one or more VTRs (or disc machines, etc.) and, in some cases, audiotape recorders; it must also provide for edit rehearse and edit execute steps.

Post-production editing can become a very expensive, slow and artistically unsatisfactory part of the program production process unless the editing system can readily be mastered by the person doing the editing. The system must be "compatible" with the editor. In other words, being able to see a field of video in freeze frame or slow motion is only the first step in the editing process. The ultimate measure of the ability of an editing system is its reliability, plus the cost and time to edit a production in one format versus any other format.

Fernseh demonstrated, at the International Broadcasters Conference in London, a frame store accessory (full frame display) which will provide the editor with slow motion and freeze-frame pictures for making critical editing decisions. It is predicted to be a relatively low-cost standalone accessory to any BCN VTR. More importantly from the editor's viewpoint, Fernseh managing director Groll emphasizes this accessory will be a part of editing systems which produce finished pro-

ANNOUNCED CONFIGURATIONS OF 1-INCH BCN FORMAT VTRS⁽¹⁾

PORTABLE CONFIGURATIONS
(ASSEMBLY-EDIT RECORDING;
PLAYBACK IN
COLOR)

STUDIO CONFIGURATIONS
(RECORD, ASSEMBLY AND INSERT EDIT,
AND PLAYBACK UNDER MANUAL
LOCAL OR AUTOMATED
REMOTE CONTROL)

AUTOMATION SYSTEM
FOR PROGRAMS AND SPOTS
(RANDOM ACCESS FOR AUTOMATIC
RECORDING AND PLAYBACK
OF SEGMENTS OR ALL OF
24 20-MINUTE CASSETTES)

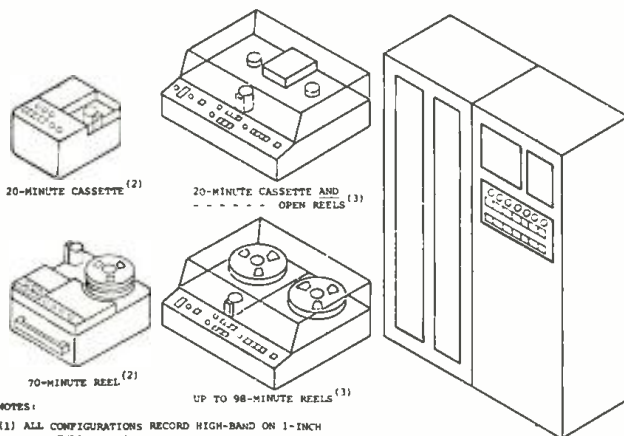

NOTES:

(1) ALL CONFIGURATIONS RECORD HIGH-BAND ON 1-INCH LONGITUDINALLY ORIENTED TAPE. VIDEO TRACK LENGTH IS NOMINAL 3.3 INCHES AT TAPE SPEED OF 9.65 LPS. THREE FULL-BANDWIDTH AUDIO CHANNELS

(2) PLAYBACK IS BROADCASTABLE AFTER STABILIZATION IN STANDALONE SIGNAL PROCESSOR

(3) AVAILABLE WITH INTEGRAL OR STANDALONE ANALOG AND DIGITAL TBC'S FOR EDITING AND BROADCASTING

Planned configurations for BCN family.

pressed the station. There is a joke going around the operation about "dubbing down to quad." Multiple dubs can be made with no fear of banding problems developing. Operationally, WHQ-TV doesn't claim better-than-quad performance, but it certainly is no worse.

In actual practice, WHQ-TV will use the one-inch portables in conjunction with quads. Two VPR-1s can be used in A-B rolls with the final recording put on quad. The station has on order a VPR-10 portable which may change such operations in the future.

Why did WHQ-TV become one of the first customers? It had been watching one-inch machines for some time and was impressed with the capability of Video Memory's highband recorder in conjunction with a TBC. But it was still worried about interchangeability. When Ampex came along with its auto scan tracking (AST)

Yet Another Format From NEC

As *BM/E* goes to press with this issue, we will not have seen the new NEC machines that were scheduled for exhibition at NAB '77. We understand NEC has its own format. And just what NEC's marketing plans will be remains to be seen. It does offer a family—a one-inch console unit, a one-inch portable A/C powered reel unit and a one-inch cartridge load unit. Some thirty TT-3000 consoles are operating in Japan according to Dennis Fraser, U.S. marketing manager. The TTR-7 cartridge unit is brand-new. It weighs only 30 lbs. and is battery operated. It records for 22 minutes.

system and a wide window (6 line) TBC, interchangeability seemed to be licked once and for all.

WHQ-TV does view the day when syndicated material continued on page 39

grams at lower costs and time spans than the competing 1-inch format systems. An important VTR editing consideration is the roll cue time from a standing start to stable picture output. For the BCN format, with its low-mass, small-diameter head assembly, this critical time is only 1.5 seconds. Automated editing systems to take advantage of this performance specification will keep the VTRs operating at a faster rate than even a super-fast editor can make and execute editing decisions.

The BCN format has *three* audio channels. Two have specs better than quad, the third is equal to quad. The third is available for time code or audio cues as needed. BCN units handle editing reliably. Edits go through the unit's analog (60 dB S/N ratio) TBC without a glitch. There are no interruptions for re-alignment or phasing for editing or for re-cueing because the unit didn't lock up in time, etc.

Cassette Portable Packaging. An indispensable advantage of the ¾-U format is the enclosed, protected two-reel cassette. A harassed ¾-U portable VTR operator in an Alaskan avalanche or a tropical cloud-burst can change tapes pretty much on demand and without moving to a sheltered location. Not so with a reel-to-reel VTR, especially one with coaxially mounted reels. To satisfy this absolute requirement for unrestricted EFP shooting, Fernseh will introduce at the 1977 Montreux Conference its BCN format, 20-pound, 20-minute recording time portable BCN-5 VTR, as a companion to the reel-to-reel portable BCN-20 with 60-minute recording time. Both have color playback facilities. Both provide *automatic* assemble editing arrangement of successive takes on the tape, eliminating annoying picture breakup at each new take as a field recorded tape is continuously previewed for in- and out-take identification.

To provide for unrestricted editing flexibility, a companion cassette editing VTR, which also handles reel-to-reel tapes, will also be introduced at Montreux. This will have all the editing flexibility that broadcasters have come to expect in ¾-U editing VTRs. Another product, first shown in the U.S. at the San Francisco SMPTE meeting will also be on display—a stand alone signal processor for BCN-20s which stabilizes their outputs for direct broadcasting.

Future VTR Application: Automatic Programming. Bob Paulson identified 19 functional applications of video recording/reproduction equipment in his chapters on VTR and *Future Developments* in the book "ENG/Field Production Handbook."* Five performance categories not requiring interchangeable recording formats were called out. The first two were: 1. ENG (low cost equipment, 16 mm quality) and, 2. sio-mo/freeze

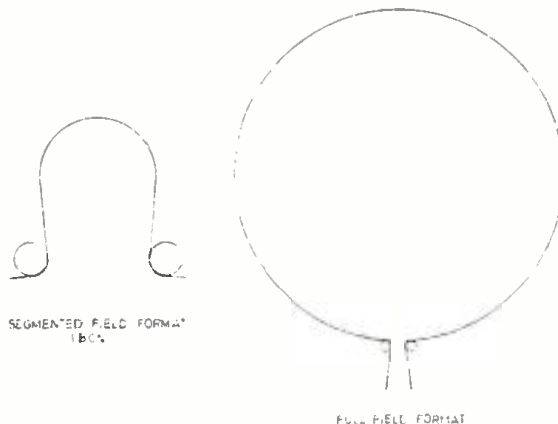

BCN segment head system left uses smaller diameter drum for fast lock up and minimum tape friction.

frame disc. The others included: 3. local station/local facility field jobs using portables where there is little need for dubbing or additional generations (much as documentaries); 4. local production using studio facilities or mobile vans (such as sports, commercials); 5. on-air playback of short length spots, PSAs, IDs, etc.

The latter three applications now rely on quads or quad cart players and occasionally 2-in. helical. Here and there one-inch IVC portables are used. All this can be done more easily and conveniently on the new one-inch professional quality VTRs.

With the addition of a random-access automatic programming product, the Fernseh BCN format will ideally satisfy the last application—on-air playback of spots, etc. The proposed configuration is a system which would accommodate 24 two-spool cassettes, not one-spool cartridges, on line, with flexible provisions for recording and editing, internal duplication and random access automatic playback. Cassettes loaded with 20-minute cassettes would provide 8 hours of continuous playback. Of course, the cassettes might also contain 30-second spots, to provide cost effective competition for the RCA TCR-100 and Ampex ACR-25 "quad cart" systems.

Answers to "When will they be introduced?" "When will they be in production?" "How firm are the specifications and features?" "What is the cost?" etc., will have perhaps been answered at 1977 NAB, Washington.

*C.R. Paulson, "ENG/Field Production Handbook," Chapter 5—VTRs, and Chapter 11, Future Developments—VTRs—p. 10. 5 and 10.6, published by *BM/E Magazine*, 295 Madison Avenue, New York, NY 10017.

CETEC Sparta's new SS1000A is really worth listening to.

For starters, our new AM transmitter produces less than 1% harmonic distortion. Near perfect. Advanced circuitry easily provides 125% modulation. So exclusive we've applied for patents.

One factor we haven't provided is "dead air." Our SS1000A behaves much like a tube type — it simply ignores load variations.

High overall efficiency? In spades. RF systems 90% or better. Remarkably low power consumption. Another plus. We use two accurate digital meters.

Each assures an automatic "spare" for the other. *Extras:* no-load, no-tuning broadband combining system. "Tally light" fault locator system and individually replaceable PA and modulation Transistors. *Interesting fact:* CETEC Sparta is the only manufacturer of both AM and FM solid state transmitters. Enough said? Not quite. Wouldn't you as a *professional broadcaster*, prefer to talk to a *broadcast professional*? . . . about the good group of products from Sparta, Schafer and Jampro.

We're worth listening to.
And—we're delivering.

 **Cetec Broadcast Group**
The Broadcast Divisions of Cetec Corporation
75 Castilian Drive Goleta, California 93017
Telephone: (805) 968-1561

Circle 127 on Reader Service Card

One-Inch VTR Formats

might come into a station on one-inch. Economics favor this. For one thing, there is only \$50 tied up in tape, not \$200, for one hour's worth of programming. Weight of an hour's tape in a shipping container is only one-third that of quad. Conversion to one-inch could lower freight bills.*

CTP Productions Flexible Competition With One-Inch

Commercial Television Productions (CTP), 44 East Sixth St. South, Salt Lake City, is a young production house headed up by Pat Pintus, an experienced broadcaster. CTP's forte has been to have vans ready to travel. Until Pintus got delivery of two VPR-1s (his order was among the first filled by Ampex), his van complement included BCC-2 cameras and VPR-1000 recorders. The BCC-2 could run out about 1000 feet from the van. With the VPR-1, Pintus can use a smaller van or carry the recorder closer to location.

Since the addition of the VPR-1 to its repertoire, CTP has been in demand by TV stations for basketball sports coverage. They have now found the VPR to be a good substitute, for the HS-100. Pintus thinks the VPR-1 could eventually replace the disc because the one-inch portable is not at all touchy and is easy to maintain—and



Camera is connected by cable to truck.

cheaper. Only thing it can't do is slow motion backwards.

Pintus says KUTV was the first Salt Lake City station to take advantage of the slow motion features. CTP was hired to supplement the station's coverage with a free roving handheld camera. But the VPR-1 was tied to the control room and any of several cameras fed to it. If some spectacular action is caught (which is monitored on preview), the director orders "take it back." The VTR operator simply runs backward for a count of 3 or 4 and the replay is ready to air. (Another mode is for the director to simply ask the VTR operator, "Do you have anything good?")

Pintus will use the VPR-1 primarily to do commercials in the local area. He shoots with a handheld camera, single camera style. Whatever is shot can, of course, be transferred to two-inch with no loss in quality. Pintus says the unit is fantastic for editing and he likes the features of the VPR-1 generating its own code. Right now CTP does not use a computer-controlled editor: it eventually will acquire one but for the present, Pintus edits from one VPR to another or to quad. He stops on a frame and jogs back and forth to pick his scenes. It's slower than using a computer editor for rehearse, preview, etc. but it is sufficient.

Pintus does a lot of editing in producing commercials. Customers include ZCMI department stores, banks, grocery stores, etc.

CTP's flexibility landed it a neat job just as *BM/E* was preparing this issue. It's covering a corporation meeting being held at the Silver Auto Country Club, Napa Valley, north of San Francisco. CTP will be taking two cameras and again be recording single camera style. This material will be transferred to IVC recorders with SMPFE time code and a rough edit tape made. This "rush" tape will be sent to the client for screening on an IVC machine for review before its final edit is made. Pintus feels the one-inch professional VTR has added a lot to his capability but his costs remain competitive. He expects lots of profit from his investment.

How and why did he select the VPR-1? Believe it or not Pintus bought it sight unseen. He was seriously considering buying a VPR-3000 portable quad. When he heard about the VPR-1, he reviewed its specs and decided this was the better way to go. After two months of actual experience he is delighted with his choice.

continued on page 40



CTP's truck on location at Silver Auto Country Club doing job for the Swartwout Productions, Phoenix.

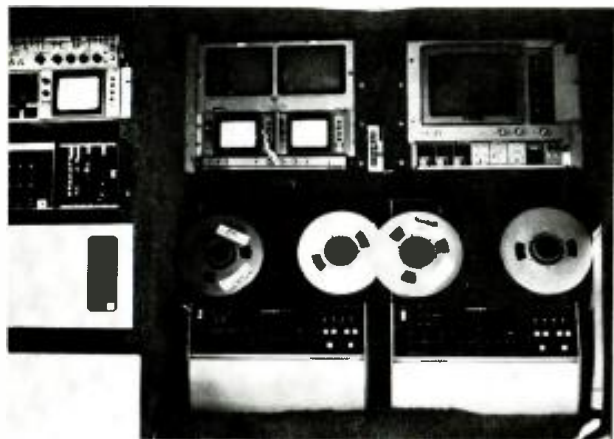

Inside CTP's truck are a pair of VPR-1s.

*Henry Zahn, Bosch Fernseh, says air freight costs are a factor that will certainly effect buying decisions. He cites Australia as a dramatic example. Since all of the principal cities of Australia lie on its perimeter, beyond easy reach of each other by microwave, tapes are sent out extensively by air freight. It has been estimated that as much as 12 tons of tape are in the air at any given moment.

One-Inch VTR Formats



Fireman's Fund, San Francisco, has two Sony recorders.



Fireman's Fund uses Hitachi SK-70 multi-role camera.

Sony Unveils Portable Omega Recorder At NAB '77

At the 1976 NAB Convention, Sony showed a prototype version of the BVH-1000 Omega 1-inch High Band Recorder. The production units now being distributed have been improved in several respects. Function controls have been redesigned to permit easier operation with more convenience. Dynamic response servos have been improved to quickly locate any edit or point of reference. Shuttle speeds have also been increased. Locked-in color can be achieved in speeds up to 7 times normal and up to 30 times normal in black and white.

At NAB '77, Sony unveiled a Portable Omega Recorder, the BVH-500. This 1-inch high band helical portable unit now offers a companion unit to the BVH-1000. Powered by a battery, this unit permits field recording and field interchangeability with studio units. A 9-inch tape reel provides up to 60 minutes of recording capability. Weight is 37 lbs., without battery.

These systems offer a quality equal to or better than quad and a cost effectiveness that will give user stations greater net operating profits.



Bosch Fernseh BCN-50 console that was delivered to N.J. Bell.

CBS To Build Super Editor

The CBS Television network has recently taken a new posture because of its effort to promote a compatible standard that both Sony and Ampex (and others that follow) might meet. Thus it prefers not to be put in a position of appearing to favor the Sony format even though it has now purchased 15 BVH-1000s. Whatever future decision CBS may make on purchasing of machines, it will use the BVH-1000 in building a new editing system which can stand alone and not be affected by interchangeability (albeit the fact that the editor would be enhanced if it could use any eventual standard format tapes).

It turns out simply enough that the Sony Omega machine, with its extra head for laying and tracking sync, is the ideal storage medium for a super editor such as the original light-pen operated CMX-600. One of the real limiting features of the CMX-600 was the difficulty of loading program material into the computer discs. It was a tedious task and storage time was limited. If a decision called for selecting something from a disc pack not in the machine, unacceptable time delays were encountered. Such problems are overcome by substituting the one-inch machine as the storage medium. Hours of material can be loaded. High speed shuttle speeds minimize access time. A SMPTE code can be inserted in the vertical interval that can be read both at high speed and in the pause mode.

Private Production Centers Pick The One-Inch Machines

One-inch professional quality VTRs look like they will be real bonanzas to private companies and institutions who are using video for training/education and communication purposes. We found three customers none of whom picked the same format. Each has had his own reasons, some of them possibly personal. Actually we talked to more than three users but most did not want to speak for attribution. Several were gun shy over appearing in print or in any way "endorsing" one format over the other.

To get reasons for this choice or the other into the

continued on page 42

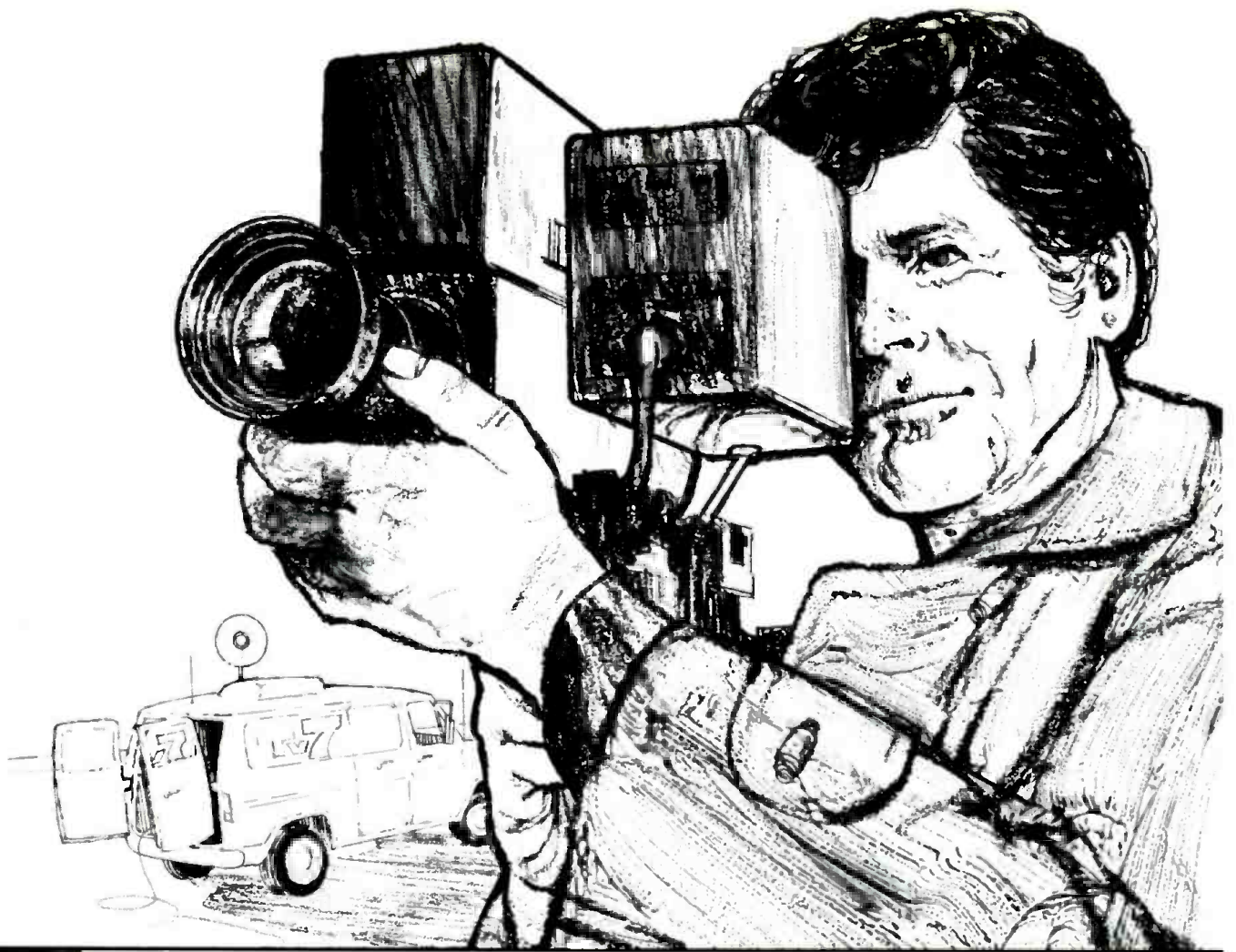

Sync and Test Signals... part of the ENG picture

There are several good reasons for including a 1470 Series Generator in your ENG specifications.

- Full NTSC sync generator
- Genlock to helical-scan VTR's
- Test signals
- Economy
- Low power consumption
- Compact

Tektronix
COMMITTED TO EXCELLENCE

Would you like to see one of these "ENG" generators? Call your nearest Tektronix Television Field Engineer. For a data sheet use the reader's service number on this page.

APRIL, 1977—BM/E

Circle 128 on Reader Service Card

41

One-Inch VTR Formats

open, we will not identify who said what.

Several of these new customers of one-inch VTRs, incidentally, are just moving into color. They have been anxious to switch to color for some time but were frustrated in deciding what to buy. None could afford the quad machines, though as one said, the RCA TR-600 looked pretty good. The ¾-U format was okay for some purposes but certainly not as a mastering machine.

The availability of the Bosch Fernseh made it the logical choice for some customers. Units could be obtained for evaluation and delivery quotes looked firm. Indeed the portable BCN 20, a key item, did just recently begin to come off the line. Availability, alone, then was a

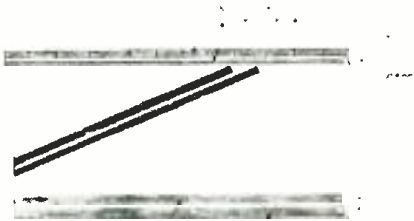

Ampex VPR-1 format.

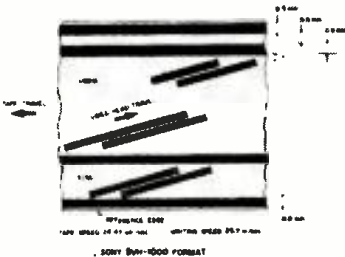

Sony BVH format.

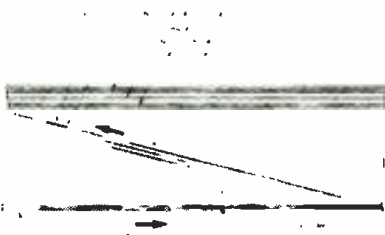

Bosch Fernseh BCN format.

IVC To Push Portable BCNs With Universal Interface

(The following is based on information gathered in early February during a *BM/E* plant visit.)

At NAB '77, International Video Corp. introduced its version of a portable BCN recorder, the model 8020. It promised delivery by late summer-early fall. As reported in *BM/E* last month, the IVC has eliminated the stacking of reels without increasing size. This means it should be easier to thread an IVC portable than it is a Fernseh. IVC also points out tape handling is gentler because of less twist in the path.

However, there is complete tape interchangeability between the two machines and scanner mechanisms; head wheels are electrically and physically interchangeable too. The 8020 weighs 45 lbs. and can record for one hour using internal batteries. The 8020 provides an assemble edit mode for recording and also has an audio insert capability on track No. one.

In conjunction with the 8020, IVC is also producing an accessory 8025 interface unit. This device, with a time base corrector, allows fully synchronous broadcast playback from the 8020 for direct airing, for editing or for dubbing to any other format.

The 8020 contains RF head switching circuitry along with both fixed and variable equalization, a full bandwidth demodulator with appropriate filters, transient suppression and output amplifier. Dropout detection keys the TBC's dropout compensator. The variable equalization is controlled by a chroma level detector and control circuit which provides for both average chroma level control and line by line chroma level control. Buffer amplifiers with optional muting are provided for all three audio channels. An optional heterodyne color processor can be plugged into the 8025 to allow a quick look color video output. This is intended to be used when the unit is operating in a mobile application rather than the full portable operation. It provides for full color playback when fully time base corrected video is not required.

Ron Fried, president, and Bob Kuhl, program manager, make a point that a broadcaster equipped with a truly portable 8020, an 8025, and a TBC can go on the air with top quad-like quality for an investment no more than \$60,000.

factor.

The Fernseh system (and we must stress system because of the availability of both a portable and studio units), offered one other very attractive reason for its purchase—its mechanical reliability.

Reliability is a key factor amongst old-time helical users. Too many have "made a career" out of keeping Ampex helicals working. Sony units have been hard to repair because of poor access.

Fernseh units looked like a safer bet to those who had less than pleasant experiences with other products. For some customers, however, the VPR-1 looks very attractive. The automatic scan tracking assures at least one-way interchangeability i.e. tapes made on any other Ampex machine can be played on the VPR-1. Old tapes that were hardly playable can now be recycled again.

Some buyers have shied away from Sony because of past difficulties in servicing them, but at least one has picked the Sony professional one-inch VTR over Ampex simply because the Sony has three separate servo motors and no belts as does Ampex.

When Sony or Ampex are favored over Bosch Fernseh, the reason is the editing features of the first two. And if BCN customers are apprehensive about their decision, it is over the fact that perhaps the other machines would be better when it comes to editing. **BM/E**

**ARE YOU SATISFIED WITH YOUR
REFURBISHED VIDEO HEADS?**

**Now
you can get
a better head
for \$825!**

Are you completely satisfied with the refurbished heads you're using now for your Ampex or RCA quad machines? Surprisingly enough, you might not be if you could inspect and test them as completely as we can, part-by-part, and tolerance for tolerance.

So what's the point? When it comes to the quality of our refurbished heads, we'll put our money where our mouth is. You pay \$895 the first time around, which is itself a full 20 to 25% below the competition. Then the price for that head drops to \$825 thereafter for the exact same refurbishing procedures you got the first time.

How do we do it? Fourth generation tooling and 18 years of experience let us give you a better product at a lower price. So, if you're not completely satisfied with your refurbished heads, send us one or a bunch and let us prove why we're better.

Incidentally, if you're interested in finding out the condition of the head you send in, ask us for an Original Condition Report. It may surprise you.

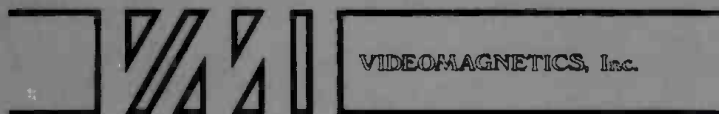

VIDEOMAGNETICS, INC.

General Office and Marketing
155 San Lazaro Avenue
Sunnyvale, California 94086
(408) 737-8300

In Southern California
Superior Video Services
(213) 786-7060

Studio and Operations
Front at Reagan Streets
Sunbury, Penn. 17801

In Texas and Oklahoma
B.O.B. Associates
(214) 434-2145

ABC Constructs A Post Production Facility Where Audio Isn't Left Out

One of the most sophisticated video post production installations pays a great deal of attention to audio

IT IS POSSIBLE TO TELL the difference between videotape and film without ever seeing the images. In fact, sophisticated viewers can stand in the other room, away from their sets, and tell the difference between the two media by simply listening.

Complaints about the audio quality of videotape productions are as old as the medium but many knowledgeable technicians have pointed out that the quality difference has been caused more by lack of attention than by the medium itself.

ABC, under the pressure of their growing sports programming, decided last September to embark on a crash program to build a superior past production facility at

their New York broadcast center. Joe Maltz, project director from ABC's Broadcast Operations and Engineering division, was determined in this construction project to build a superior video post-production system, where audio would not be the forgotten step-child.

ABC's Broadcast Center has burrowed and built a labyrinth of facilities on and under Manhattan's West-side. Unlike the "space-center" appearance of more recently constructed broadcast facilities in the wide open space of modern America, the ABC operations are more reminiscent of a secret CIA installation dug into the bowels of some mysterious and remote mountain. Every possible inch of space is used. Entrances and exits are hard to find and commodious accommodations are at a premium. Nevertheless, when it came time to build a new post production facility, Julie Barnathan, president of Broadcast Operations for the network, decreed that space would be provided to accommodate, comfortably, the creative people who were to put in editing sessions lasting anywhere from 12 to 20 hours.

The criteria were laid down: a state-of-the-art video post production system, with the ability to accommodate new technology when it becomes available; an environment that would minimize fatigue; a degree of attention to audio processing that would elevate it to an equal status with video.

What ABC achieved is enviable. The video facility employs three Ampex AVR-3 recorder/reproducers and two additional Ampex VR-2000s for added VTR capacity. Currently the edit controller is an Ampex RA-4000, but ABC has designed the facility to accommodate an EDM-1 when they are satisfied with the performance of the new machine. For primary audio treatment, the facility includes an MM-1200 multi-channel audio recorder. Additional audio "sweetening" is possible in a separate facility (discussed later). The current switcher employed is a Grass Valley 1600 2B audio follow video switcher, customized to ABC specifications. Later, ABC will probably move to a new Grass Valley with digital effects or Vital digital effects switcher depending on an analysis of the competing systems after ABC has a chance to compare them at NAB. In addition to the VTRs, there are three additional connections available to the broadcast Center's 100 x 100 routing switcher.

The additional capabilities of the video system include a Chyron graphics and titling system and an Ampex HS-1000 slow-mo machine.

The facility itself is specially lighted and environmentally controlled. A rest area, complete with leather sofa, lounge chairs and wall-to-wall carpeting, provides the relaxed environment the creative people need.



View of the ABC million dollar post production unit. Aimed at editing ease and the latest technology, nearly every piece of equipment is within easy reach or view.



AVR-3s are housed in environmentally controlled room and form the basic VTR capability for ABC's facility.



After installation, Joe Maltz, project director (second from right), gets a feel for the new facility.

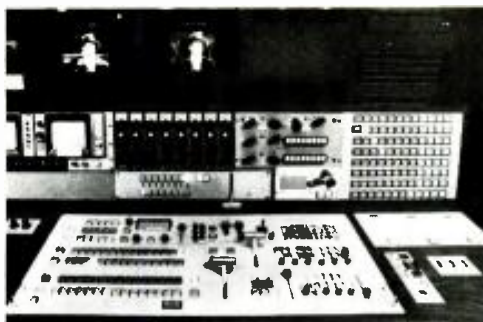

Operator's eye view of controls, switcher, and video source selector incorporated into main panel of the editing facility.



Comfort plays a large role in the design of the new facility. Editing sessions may last anywhere from eight to twenty hours so in addition to the comfortable swivel chairs provided at the panel, a plush living room environment is provided in one corner of the room for R&R and conversations.

The three AVR-3s are housed in a separate room to avoid machine noise interfering with the production staff but visual contact with the VTRs is maintained through glass partitions and a special mirror which permits viewing of the transports. The VTR room is environmentally controlled and positively pressurized. The vacuum system is tied into a central system and machine control is remoted to the control room. Two additional VTRs are housed in another room and when in use, a drape is pulled back to bring them into view through another glass partition.

The control panel puts most controls within easy reach of the TD, who like other personnel, sits in expensive but very comfortable sculptured chairs. The director and creative people have full view of a wall mounted monitor for each input, preview and program. Elapsed time clocks are provided in both digital and sweep configurations to accommodate any preference. Also in view of the creative personnel are auxiliary rehearsal and edit lamps to help keep them advised of the status of the situation. A duplicate digital readout from the RA-4000 is also located in view of these personnel. The automation permits pre-programming of transitions and the audio follow video switcher allows the director to treat audio transitions and video transitions separately as well as simultaneously.

As Joe Maltz puts it, "these people love telephones," so numerous telephones are provided both in the room and on the editing console to provide immediate communication with the entire ABC plant, as well as the outside world.

The room is acoustically protected but taken into consideration is the need for the producers to hear how the audio is reproduced on a normal home receiver. So, a small dish speaker, much like a stock home receiver's speaker, is provided in a handy little box that can be jacked into the audio output for the producers information.

The facility was predicated on the expected demand by ABC Sports but it was understood from the beginning that other production divisions of ABC would probably call on the facility. The audio capability of the basic post production facility can easily accommodate the demands of the news department but Sports wanted more audio

processing. To achieve this, the former post production unit was converted entirely to the purpose of improving the audio track.

In the case of ABC's "Superstars" production team, the audio processing in the basic facility is not as thorough as they like. When they've finished the video portion, they move to the audio room. Here, there are 6 audio cart machines, 1 variable speed cart machine, a sound effects unit, an eight channel recorder and a number of audio filtering systems. Also, the small home speaker accompanies them to provide a constant gauge of how the program will sound to the home viewer.

In addition to all the audio equipment, a screening room and announcers booth are located off the main room. There, announcers can screen the video, plan their comments and record the commentary for mixing into the program.

In the "Superstars" competition, the original audio track is a mess of unequalized crowd noise, screeches, thumps, grunts, and everything else you would expect to hear if you recorded a company picnic. The program's staff and ABC's technical crew perform near magic in the audio room.

A variable notch filtering system plus graphic type equalizers are used in conjunction with the eight channel recorder and sound effects unit to smooth and sweeten every inch of the sound track. About five technicians at this stage are assigned to the care and feeding of sound. As Joe Maltz points out, "Here, we are very concerned with audio," so every element is carefully checked and produced to the specifications of the creative team. Julie Barnathan has given the engineering and operations team a set of priorities: Satisfy the creative production team first, then worry about operations, and finally, maintenance.

Audio is still a weak point in television but at least at ABC, the audio quality of videotape going into the transmission/reception chain is just about as good as it can be. What remains to be done by the industry now, is the development of better audio transmission and better home receivers to reproduce accurately the quality imparted to the audio track by crack professionals like those at ABC.

BM/E



The BVH-1000.

Consider the advantages.

Last year, Sony Broadcast introduced the prototype of a new 1" high band video recorder. The BVH-1000.

The BVH-1000 produced picture quality difficult to believe. In fact, broadcasters didn't believe it. They had to see it for themselves. And they snapped up every prototype we could deliver.

Since then, we've made some changes. Added more features. Expanded the BVH concept to include a portable model, the BVH-500, for professional 1" production in the field.

And we've sold a lot of machines.

If you're considering the move to 1", consider the advantages of the BVH-1000.

1. The Advantage of Shared Sector Scanning. The Sony Broadcast BVH-1000 and BVH-500 both use an exclusive system of scanning that records video and sync (lines 1-17) with separate heads. Which means the entire vertical interval is captured and available for encoding any signal required in the future by the FCC.

Color banding is eliminated. And generation after generation, the BVH-1000 picture retains incredible clarity and precision.

2. The Advantage of BIDIREX. Film editing techniques, with a professional video recorder?

That's what you get with the BVH-1000. Not one, but two control modes are provided to give editors a true "film" feeling. In shuttle mode, the tape can be moved in either direction, from stop to 30 times normal speed. With a recognizable picture, so you can make fast editing decisions.

In jog mode, the BVH-1000 lets you move the tape as though you were positioning the reels by hand—while you monitor a fully locked picture.

3. The Advantage of Interchangeability. 1 dB down is the specification. Need we say more?

Sony's interchange is guaranteed by a gimmick-free devotion to precision mechanics and supported by the experience of building several hundred thousand video recorders.

4. The Advantage of Color Framing. Some high end production recorders don't offer color framing. Others make it available as an expensive option.

But both the BVH-1000 and BVH-500 provide color framing capability as standard equipment. Add that to a logic system ideally suited for computer assisted editing, and the Sony BVH-1000 is your best bet to produce that "word from our sponsor."

5. The Advantage of High Fidelity Audio. Not one, not two, but three isolated audio tracks with frequency response from 50 Hz to 15 kHz. With over 50 dB isolation between tracks.

Never before has any production recorder offered the level of audio quality found in these two new Sony Broadcast machines.

And a special wide band amplifier is automatically switched onto the cue track in search mode, to accommodate SMPTE code playback in high speed.

But it is impossible to describe all the advantages of the Sony BVH-1000 and BVH-500 high band recorders. You must see them to believe them.

Contact Sony Broadcast today, and ask for a demonstration. You'll see why networks and production companies alike are buying this remarkable new recorder.

Sony Broadcast

Sony Corporation of America, 9 West 57 Street, New York, New York 10019 (212) 371-5800.

Sony* is a registered trade mark of Sony Corporation of America.

Circle 130 on Reader Service Card for literature

Circle 131 on Reader Service Card for a demonstration

Introducing the Newvicon™ color camera from the people who invented the Newvicon tube.

Up to now, there were just two kinds of color studio cameras. The kind you wanted. And the kind you could afford. But now there's Panasonic's new color studio camera and control unit, the WV-2150. At around \$6,500 (not including lens), it gives you the professional results you want at a price you can afford.

First there's Panasonic's Newvicon tube and all the sensitivity that goes along with it. All you need is 200 footcandles of standard illumination at $f/2.8$. And with a flip of the 6 dB gain switch, only 25 footcandles is required at $f/2.0$. There's also a S/N ratio of 46 dB with standard illumination. As well as a stable

color picture that's sharp and clear. With a maximum of resolution. And a minimum of blooming and burn-in.

The 2150 also includes automatic pedestal circuitry. Automatic color level contours for both high and low light levels. Horizontal and vertical aperture correction circuits. As well as new dynamic focusing circuitry for sharp, even focus over the entire tube.

The camera control unit features a flip-down front panel for easy access to all critical controls and adjustments. What's more, all printed circuit boards can be removed from the front. Also included is a self-contained subcarrier phase shifter with coarse and fine phase adjustments.

For less stringent requirements, take a look at the WV-2310. Panasonic's new lightweight color studio camera. At around \$4,250 (not including lens), it comes complete with two vidicon tubes. A 3" viewfinder. And its own professional-type camera control unit.

So, if the color studio camera you've wanted hasn't been the one you've been able to afford, look again. At Panasonic.

For more information, write: Panasonic Company, Video Systems Division, One Panasonic Way, Secaucus, N.J. 07094. In Canada, contact Panasonic Video Systems Department, 40 Ronson Drive, Rexdale, Ontario M9W 1B5.

Panasonic
just slightly ahead of our time.

Circle 132 on Reader Service Card



AM Stereo: If You Want It Now Is The Time To Tell The FCC

The National AM Stereo Committee will start testing five AM stereo systems in April. The NASC report should be in the hands of the FCC a few months later. It's possible there could be an approved system before the end of this year. Your speaking up will help.

IF THE VIEW WE ARE NOW getting of AM stereo turns out to be permanently valid, American broadcasters might be able to radiate a stereo signal on AM carriers sooner than you think. The benefits could be enormous.

The National AM Stereo Committee (NASC) of the EIA has said its tests of proposed systems will start this April and its report will go to the FCC, hopefully, in late summer. The report, of course, is advisory only: the FCC can choose any system it believes is the best. It could even institute supplemental tests of its own (as it is now doing in the FM quad inquiry—see box).

But with good luck, the decision *can* be wrapped up this year yet. But broadcasters who want AM stereo as

soon as possible must let the FCC know that fact.

At this moment, AM stereo looks both easy and profitable, a great combination. Standard AM transmitters of high quality will do the job without major modification, except for new stereo exciter and monitoring units. The cost of those two units taken together is likely to range from a low around \$3500 to a high around \$10,000, according to some estimates made for *BM/E* by manufacturers in the field.

Mono studios and audio lines have to be converted to stereo, but for that, the broadcaster can choose almost any cost level he wants. Many AM stations already have control consoles with stereo built in.

The origination units the broadcaster uses—open-reel and cartridge tape machines, disc playing equipment—have, of course, been standardized on stereo for a long time and they are comparatively inexpensive equipment in any case. Recorded program material is universally in stereo.

In the listener's living room, stereo playback equipment is most likely to be already in place, either as a hi-fi system or part of an existing FM stereo set. The missing link for AM stereo reception, the AM stereo receiver, will be easily produced and priced little above mono receivers of comparable, and at least reasonable, quality; it will be to receiver manufacturers a highly welcome new product. AM design at the lowest price levels probably won't be adequate for a stereo receiver because severe IF band-limiting can't be tolerated in most AM stereo systems. (But the cheapest AM mono receivers will get stereo signals acceptably)

Will the AM station in a small or medium market win listeners with stereo? The general opinion in the industry is that AM stereo will strongly boost audiences in many market situations. Stereo reproduction is today universally understood and accepted by the public. The "image" of a station introducing stereo, and letting the public know the fact through effective promotion, is sure to gain in appeal.

The special acoustic qualities of stereo in a car will supply important leverage for many AM stations. Car owners have learned to enjoy the accentuated separation and "big hall" effects of car eight-track tapes and FM stereo systems. With stereo, the AM broadcaster will be in a much better position to win and hold car listeners.

The tests that will lead to a recommendation to the FCC by NASC will be carried out in Washington. Two local AM stations, one at the low end and one at the high end of the band, will put test material on the air, and the committee is renting evaluation equipment, including a

FCC Sets Up Its Own Listening Test In FM Quad Proceeding To Supplement NQRC Report

Exhaustive as the NQRC report on FM quadrasonics was, there was one important omission, recognized in the industry and noted in *BM/E*'s February, 1976 report: the comparative listening tests did *not* include a matrix system with advanced logic decoding. This was not the fault of the NQRC: both Columbia, with its SQ, and Sansui, with QS, had withdrawn from the NQRC tests. The matrix system which NQRC compared with discreet systems, in tests which the discreet won handily, was a simplified design by Cooper-UMX which had far less separation between channels than that supplied by the latest matrix decoders.

The FCC has now undertaken to remedy this by setting up its own tests between discreet and matrix to supplement the NQRC report. Evidently the developers of matrix systems were willing to join in tests directly by the FCC while avoiding those of the advisory NQRC.

The FCC tests, as described to *BM/E* by a spokesman at the FCC, will be extremely thorough. Listening panels will make "blind" judgments on comparative localization as well as on musical preferences. The tests are taking the FCC deep into psycho-acoustics; already they have found that loudspeakers of very special quality are needed to avoid serious listener fatigue.

The panels will include a very wide range of listeners, from personnel at the FCC lab trained in electro-acoustics, to music students at the University of Maryland, members of local symphony orchestras, rock and pop musicians, plus a large contingent of persons without special musical background.

Although these tests are probably delaying the FM quad decision a year or more, we can be glad that the issue of discreet—vs—matrix is getting more thorough examination. If the FCC in the end does decide that discreet quad is enough better than matrix to justify inauguration of discreet, the decision ought to be widely acceptable.

AM Stereo

mobile test van, to check results throughout the reception area. In addition, some checks will be made on transmissions from WBZ in Boston to see what happens on the skywave, Boston to Washington.

As this was written, four companies had submitted proposals and supplied prototype equipment to NASC to undergo the tests and evaluations: Belar Electronics, Comm. Associates of Hewlett, L.I., Magnavox and Motorola. A fifth company, Kahn Communications of Freeport, L.I. earlier submitted a comprehensive proposal directly to the FCC and asked for a ruling establishing that system as the standard. *BM/E* learned that both NASC and the FCC were urging Kahn to submit their system for testing along with the others. Two of the companies which had submitted proposals at the time of *BM/E*'s February 1976 report, RCA and Sansui, have withdrawn.

The five systems

Here are quick outlines of the five systems.

Belar Laboratories. This is the system that RCA has described and demonstrated at several recent exhibitions—RCA has withdrawn in favor of Belar in its presentation to NASC and the FCC. It starts by matrixing the L and R channels into L+R and L-R (as most systems do). The L+R is applied directly to the amplitude modulator on the transmitter, to supply the "sum" signal for monophonic AM reception. The L-R goes through an "angle" modulator to impress frequency modulation on the RF source before it reaches the AM modulator.

Thus the carrier that reaches the RF section of the transmitter has both FM and AM sidebands, the FM carrying the L-R or stereo information, the AM, the L+R or mono information.

A standard mono receiver demodulates the AM sidebands only, to recover the L+R signal. In a stereo receiver, the IF signal is also fed to limiters to remove the AM, and to an FM demodulator to recover the L-R signal. Matrixing produces the L and R signals.

Comm. Associates. This system is quite different from the others, using a technique called "Frequency Aperture Modulation." It uses two back-to-back signals, one on a carrier a little below the main carrier, the other on a carrier a little above the main carrier. One carries

the left program material, the other the right.

The two go together to a band-pass filter which spans just the upper sideband of the lower carrier plus the lower sideband of the upper carrier (see drawing) and this is the transmitted signal. A standard AM mono receiver tuned to the main channel will get both sidebands, or a sum signal. The stereo receiver includes filters which separate the two signals, with two separate IF strips and demodulators, one for each channel. Matrixing is not needed in this system.

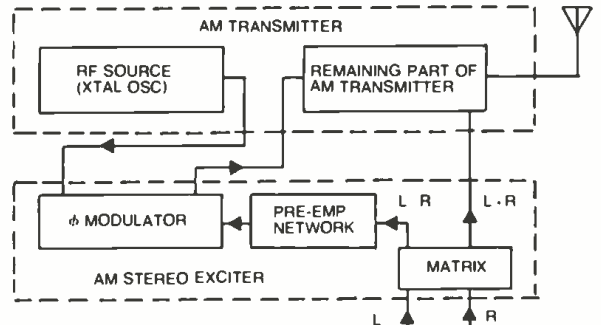

Routing of L+R and L-R signals through Belar AM stereo transmitter is shown in functional block diagram above.

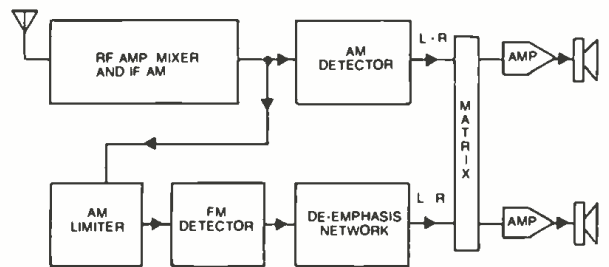

Belar receiver has two IF paths, one to regular AM detector, one through limiter stages to FM detector.

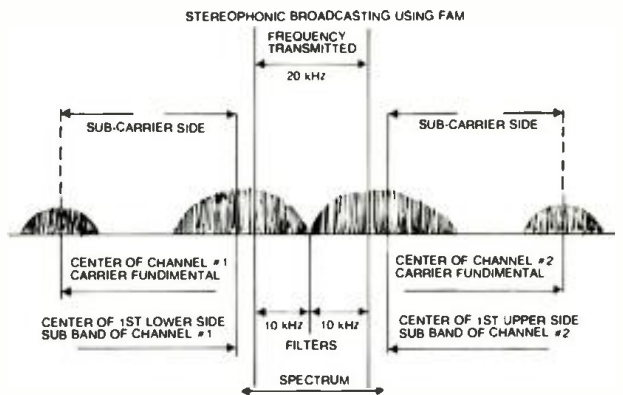

Spectrum of signal transmitted in Comm. Associates system shows how filter passes upper sideband of lower subcarrier, lower sideband of upper subcarrier.

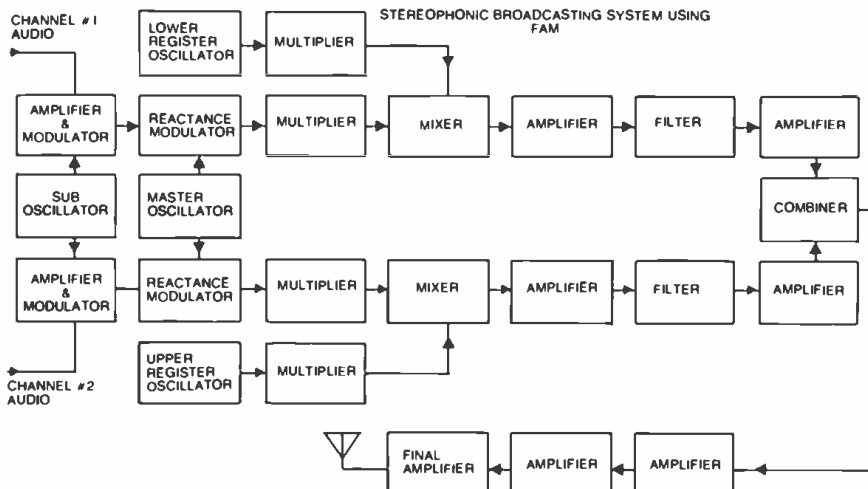

Transmitter of Comm. Associates method uses dual RF-modulator paths, one for upper subcarrier, one for lower; matrixing of L and R signals is not necessary.

Stereo can also be received on two AM mono receivers, one tuned to the upper carrier and the other to the lower. William A. Hayes of Comm. Associates, developer of the system, claims excellent fidelity and noise characteristics, plus the well-known high efficiency and reduced interference advantages of single-sideband suppressed carrier transmission.

Kahn Communications. This is a system in which the carrier is first *phase modulated* with the L-R signal, and then *amplitude modulated* in the standard way with the L+R signal. Elaborate constraints are used on the phase modulation deviation, on the AM modulation and on the relations between the two to insure low distortion, low-interference performance and also to produce a carrier with the left signal on one sideband and the right signal on the other sideband (in addition to carriage by the dual modulation). Thus stereo can be received on two standard mono receivers, one tuned slightly above the carrier and the other tuned slightly below. At the same time, a single mono receiver tuned squarely to the carrier will get the full AM envelope modulation, or the L+R sum signal; and a receiver with a phase detection system added can get the L+R and the L-R separately, for matrixing back to the L and R signals.

The Kahn system has had very extensive testing in the field. Station XETRA, in Mexico, used the system for a long period, and the results in the Los Angeles and San Diego areas were reported to be entirely satisfactory as to freedom from interference, and for stereo and mono reception. Later, WFBR in Baltimore got experimental authorization from the FCC to use the Kahn system over an extended period in 1974. The management of that station, as *BM/E* noted in the February, 1976 AM stereo article, called the results satisfactory in all respects, with the "two-receiver" method producing stereo with a minimum of about 15 dB of separation, and with specially-built stereo receivers producing at least 35 dB of separation.

It is understandable that the FCC would, even so, like the Kahn system to go through the same tests as the other proposed systems, to get directly comparable findings. But the NASC tests, as already noted, are "informational" only; the FCC can in the end make any decision it chooses.

Magnavox. This company has entered the AM stereo race, at least in part, we may guess, because of the outlook for sales of this new kind of radio receiver—
continued on page 52

One Broadcaster Is Very Enthusiastic About AM Stereo

Frank Blotter, president, WKDC, Elmhurst, Ill., is extremely excited about AM stereo. He speaks from some experience on the subject. His station participated in the initial experimental testing of the Motorola system.

WKDC was granted FCC authorization to participate back in October of 1976. The station was ideal because it is a low-powered two-tower station located only 16 miles from the Chicago loop. Its listeners are bathed in strong RF fields from many stations. Built in 1974, the station already had stereo audio consoles installed.

Testing, under the direction of Norm Parker and Frank Hibert of Motorola, began in December. Two AM stereo receivers built by Motorola were used. Blotter reports every frequency of an oscillator was used over and over again—first on one channel then another. Music was used too. After several nights of after-midnight broadcasting of music, a request was made to transmit daytime AM stereo. This was granted immediately and morning broadcasts then augmented the midnight tests. Preselected music with a wide spectrum range was aired and received through the use of a six-foot criss-cross directional AM stereo antenna with a coax lead in. WKDC recorded both the nighttime signals and the same passages during the day on "flat" equipment for comparison: (A TEAC deck and high resolution Sony amplifier under the supervision of Potter and Moore Sound of Chicago was used).

Blotter said there was some nighttime skywave interference picked up as was expected but that the daytime broadcast was startling. Says Blotter, "As a broadcaster with 42 years in this business, I can say that I was very enthused with what was heard on the air."

Listeners were informed that there would be a brief shutdown to make the transmitter changes to accommodate stereo. The station then went back on the air in a couple of minutes with stereo, eliminating first one channel and then the other. Many listeners phoned in reporting that the reception was wonderful (on their mono receivers). They said they could hear the channel separation as announced very well.

The next step is, of course, the tests in Washington, D.C. conducted by NASC.

Says Blotter, "It is our hope that what Motorola did with AM stereo at WKDC will fit into the FCC engineering requirements and that all of us will be in AM stereo before the end of 1977. With the need for new station equipment and consumer receiving sets, our industry will contribute to the resolution of unemployment problems now facing our country."

Blotter will have taken his tape recordings of the experiment to the NAB convention. If you didn't get a chance to hear them, give WKDC a call at (312) 530-1530.

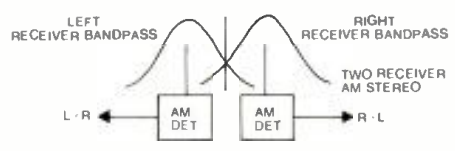
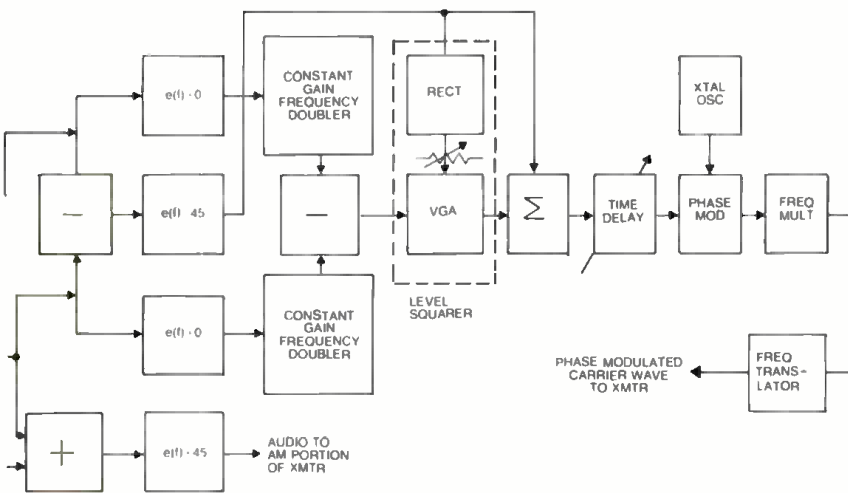

Kahn AM stereo signal can be brought in by two AM mono receivers, one tuned a little high, the other a little low.

In Kahn transmitter, L-R signal phase modulates RF from crystal oscillator. One sideband carries the L signal, the other the R signal, for pickup on two mono receivers. Single receiver with phase detection also gets stereo.

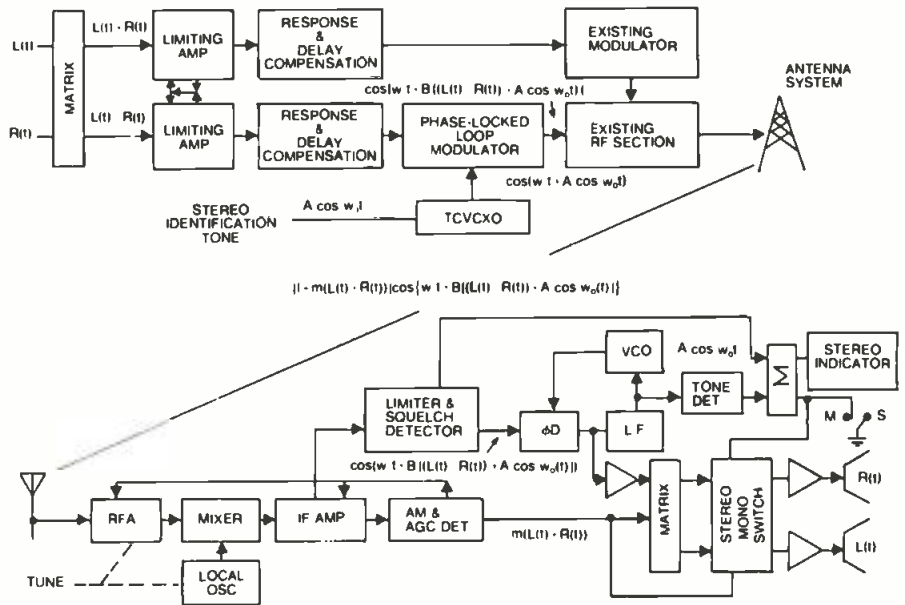

Block diagram shows both transmitter and receiver of Magnavox system. Formulas describe the signal at various stages.

other vote for the system from a strong source. The Magnavox system uses dual modulation (like Belar and Kahn), in this case AM for the sum signal and phase modulation (PM) for the difference signal. The phase modulation has a proposed deviation of 1 radian. In addition, a 5 Hz sub-audible tone is frequency-modulated onto the carrier with maximum deviation of about 100 Hz. This tone can be used for stereo identification.

As shown in the block diagram, the station carrier is generated on frequency and modulated with the 5 Hz tone. This signal is then used as a reference for a wide-band phase-locked loop to generate a PM signal on frequency. Then the signal is amplified and modulated by the sum audio signal in the transmitter's regular circuitry.

The only important change in the transmitter is the replacement of the channel oscillator with the PM signal generator and signal tone source. The sum signal is handled just as any mono signal was before the change to the stereo exciter.

Magnavox has given considerable thought to audio processing in the system and says that simple limiting and compression of the L and R signals will cause a loss in loudness for the mono listener, compared with the mono transmission case, because L and R limiters would have to be ganged, and each channel could then be given only 50% of the total modulation. Magnavox offers as a solution to this problem limiting and compression of L+R and L-R after matrixing, as shown on the block diagram.

In the receiver there is a single IF system, fed in parallel to an envelope detector for the L+R and to limiters and a phase-lock loop circuit for detecting the phase modulation.

Motorola. This system, called "C-Quan" by Motorola, uses two carriers on the same frequency that are in phase quadrature (like the two sub-carriers for color in television). Techniques for generating the dual signal and transmitting it with a single transmitter are described in detail by Motorola.

In addition, Motorola points to a source of distortion when a signal with stereo information is received on monophonic receivers, because of a complexity in the relations of the modulation components. This is eliminated, in Motorola's proposal, by modulating both the in-phase and quadrature components by the cosine of the modulation angle: hence the name of the system.

In the receiver the IF is fed to both an in-phase and a quadrature detector, as shown in the diagram. The VCO and phase-shift elements are used, in effect, to remove the cosine term added in the transmitter. The two channels go to synchronous detectors for direct recovery of the L and R signals.

BM/E wants to emphasize that the above very brief descriptions do not come near doing justice to the detailed engineering that has gone into each one of the proposed systems. On the face of it, each of the proposals is persuasive; and this is positive for the AM stereo outlook. No doubt the more subtle difficulties and differences that surely exist will be uncovered in the tests now under way.

BM/E

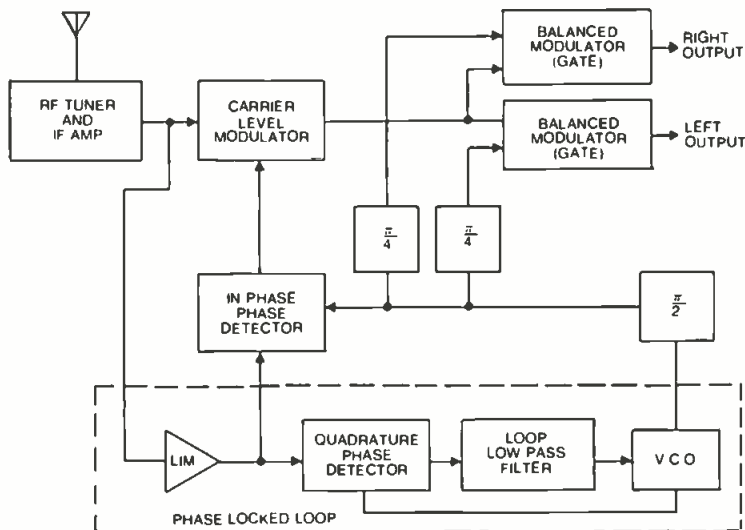

Motorola receiver includes both in-phase and quadrature phase detectors plus phase shift system for removing cosine modulation inserted in transmitter.

First they cut your budget. Now they scream for video quality.

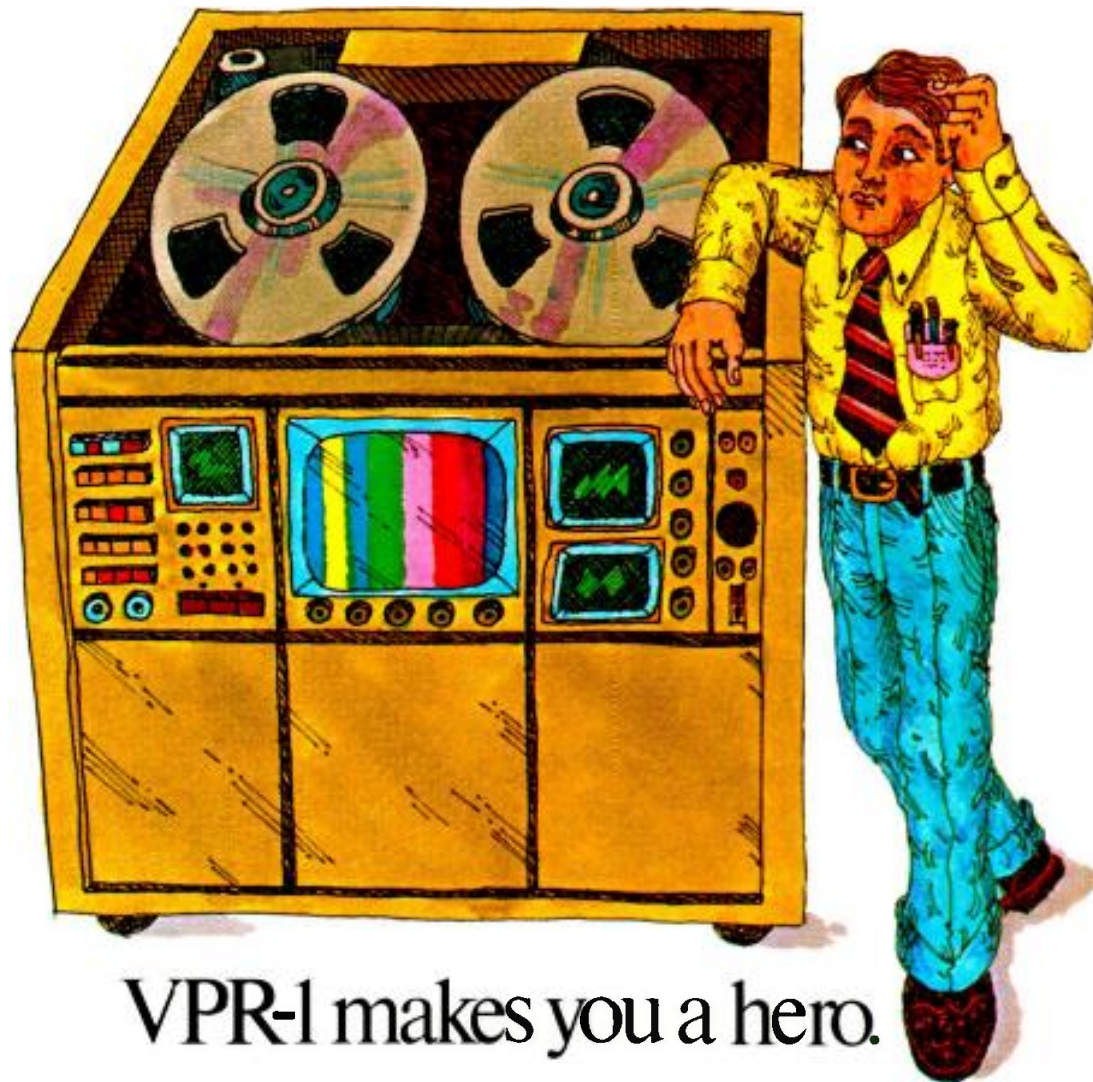

VPR-1 makes you a hero.

The unbelievable new VPR-1 produces spectacular high-band color pictures in a one-inch helical format. Viewed side-by-side against a quad machine, it astounds professional engineers.

You'll probably buy your VPR-1 because you want top quality and versatility priced to suit your budget.

But once you get your feet wet, you'll



want to add the optional Automatic Scan Tracking (AST) accessory. It upgrades your VPR-1 to an entire *system*, with one-fifth speed slow motion, still frame, manual jogging, and real-time video verification features. Add the optional digital time

base corrector, and the entire bag of tricks

can be broadcast commercially, without compromise.

You can put in-house productions on the air, because they'll have all the polish, creativity and audience appeal of network programs. That's the league a VPR-1 puts you into.

VPR-1 is the one-inch helical recording system from Ampex, designed for users who can't take chances.

AMPEX

Complete technical and performance specifications are available in a free brochure. Write us at 401 Broadway, Redwood City, California 94063, or call (415) 367-2011.

Circle 133 on Reader Service Card



The fire, earthquake, election and touchdown company now brings you love scenes in Studio Two.

The new HK-312 studio camera from Ikegami, the ENG experts.

Wherever there's been news, from natural disasters to national elections to sport events, Ikegami ENG cameras have been there with the news teams. Now Ikegami makes news of its own: the introduction of our new state-of-the-art HK-312 studio and field camera.

We've built ENG cameras so good in the rough-and-tumble of news-gathering that more Ikegami ENG cameras are in use than all others combined. So imagine how good an Ikegami camera can be in the stable environment of a studio.

Very good indeed.

Ikegami's new HK-312 color-TV camera is like no other. It has a built-in minicomputer that helps trim the daily camera checkout from a one-hour ritual to an automatic run-through that's shorter than a 20-second commercial. With its auxiliary computer, you'll be able to cycle your Ikegami HK-312 (and up to four other Ikegami HK-312 cameras linked to it) through every adjustment parameter in under two minutes: white balance, black balance, flare correction, gamma correction, video gain, beam alignment, and eight registration functions.

All this before you start shooting. The HK-312 gives you three 30-mm Plumbicon tubes for highest picture quality. You frame your shot on a high-intensity, high-resolution, seven-inch tiltable viewfinder. Signal-to-noise ratio is better than 54 dB.

We've combined the zoom lens and camera tube into a single rigid assembly for highest accuracy of the optical axis. Class-A deflection amplifiers assure maximum linearity and best picture quality. Black level balance correction is automatic. Picture quality and brightness are maintained in spite of flare.

A complete two-line image enhancer provides horizontal and vertical detail correction. A special comb filter keeps background noise to a minimum.

All this and a lot more.

If your budget or production requirements are smaller, use our tried-and-tested TK-355 studio camera. Five were used for network feed at the 1976 Democratic National Convention where camera failure would blow a lot more than a few fuses.

Camera-control unit for the HK-312

The TK-355 uses three 25-mm Plumbicon tubes which are bias-lighted for reduced lag at low lighting levels. This reduces studio lighting and air conditioning power consumption. And the camera is more compact and lighter, a little easier to maneuver. The unique half-rack CCU facilitates multi-camera studio installations.

Both broadcast cameras use TV-81 minicable for ease of handling.

If you need a small, fixed-position camera for announcer booth and news-casting, check out the Ikegami HK-309. It can be operated remotely or simply turned on and left in fixed position.

For movies, the Ikegami TK-950 is a large-image film-chain broadcast camera system for 16-mm or 35-mm film or slides with highest quality color reproduction. Much of its operation is automatic, requiring a minimum of engineering support. Its unique optical system is dust-shielded and unusually compact.

Ikegami has been famous for its ENG cameras for a long time. Now take a look at what we can do with studio cameras. For specs or a demonstration, get in touch with us. We have nation-wide distribution.

Ikegami

Ikegami Electronics (USA) Inc., 29-19 39th Ave., Long Island City, N.Y. 11101 • (212) 932-2577

Plumbicon is a registered trademark of N.V. Philips.

Circle 134 on Reader Service Card

PICK YOUR BEST SHOT



End your still library woes forever with the new ESP-100 Electronic Still Library.

Now you can produce and store stills instantly using latest generation microcomputer technology. Get a better picture in seconds instead of hours. And save up to \$20,000 a year in still production and library overhead costs.

There's a better way than relying on 35 mm slides or graphic cards. The ADDA ESP-100 creates stills reliably, electronically, and stores them permanently. Choose your inputs: VTR, slide, film, graphic card or remote camera feed.

Once the still is captured it's converted to digital impulses and stored in the system's disk memory—untouched by human hands. You retrieve your still in half a second by pushing a bur-



ron. Select one still, edit several or sequence an entire program automatically. You have up to 400 stills on-line, ready for use. And each disk pack stores 100 images in safe, goof-proof off-line storage.

Think of it. No more costly, time consuming slide production. No more lost or damaged slides. No more slide chain problems. No more embarrassing on-air blunders. Think of it. Then think of ADDA.

Call or write today for a brochure and specs. We're doing our best to end your video slide library woes. Forever.

1671 Dell Avenue / Campbell, CA 95008 / (408) 379-1500

Circle 135 on Reader Service Card

ADDA CORPORATION

NATPE Conference Produces Biggest Turnout Ever, New Trends, And Some Controversy

Bad weather in Miami Beach helped keep more than 200 television programming executives, syndicators, and producers deeply involved in their annual meeting there where new trends in programming, governmental regulation, a proposed rewrite of the 1934 Communications Act and the high cost of doing business were the chief subjects discussed.

The trends in programming seemed to be away from game shows and animal shows in access time and an increased interest in locally produced magazine format shows, some run in strip schedules.

The governmental regulators were there in force with Chairman Wiley making a major address to the conference calling for more self-regulation and less government involvement and describing the FCC investigation of the networks as a necessary step to insure a competitive market that will produce the variety of programming the public deserves.

Congressman Lionel Van Deerlin wound up defending his proposed rewrite of the 1934 Communications Act before a room of mostly skeptical broadcasters doubtful that much could be gained from "a basement to attic" rewrite of the act that couldn't be ac-

complished better by further amendment. About the only supporters of the rewrite besides Van Deerlin were Group-W president, Donald H. McGannon, and Teleprompter president Russel Karp.

Though there was much complaining about the high cost of product, the hospitality suites of the various program suppliers were very active and local programming executives were buying to fill much of their schedule. The cost of product, said some broadcasters, had risen as much as 100 percent, forcing some anti-barter holdouts to entertain that alternative more seriously.

Local Strip Shows Make It At NATPE

An NATPE morning session in Miami, entitled "The Local Strip Show—Trend or End?" determined early in the discussion that there was a definite trend and no end.

The panel consisted of Bill Hillier, executive producer of the KPIX program, "Evening—The MTWTF Show"; Bob Lewis, KGCO-TV, Portland, representing their "Evening" show; Dave Fox, KCRA-TV, Sacramento, operations and program manager, representing "Weekday"; and Irwin Starr, WMAL-TV, Washington,

D.C., there on behalf of their show, "7:30 Live." Of the four panelists, only Starr remained unconvinced that this access show was the way to go, though he was optimistic.

The four programs represented were basically magazine format programs delivering diverse human interest type material. All but KPIX produced the shows either directly through their new departments or in some affiliation with news and public affairs. KPIX operated the show autonomously under the programming department. (See Television Programming Column for detailed story on "Evening, The MTWTF Show.")

Though such local shows are relatively expensive, in each case they had either taken first or second in the ratings against local competition. Starr estimated that WMAL spent about \$400,000 a year on "7:30 Live" and others agreed that they might be spending nearly \$100 more per hour for local strip shows than for comparable syndicated packaged programs.

The advantages, however, were better ratings for the most part, the invigoration of the schedule, and in some cases, these programs are logged as public affairs. The local strip show requires time to build ratings. Each show's ratings began low and built success over a period of time.

For the most part, the shows are produced with ENG-type equipment either in whole or in part. Those using film predicted an increasing role for ENG within the programs. The only element that might be in short supply is talent, though the general feeling was that most any competent news department could provide five to ten minutes of the program material with the remainder coming either from outside sources such as freelance filmmakers or perhaps other stations.

Wiley Seeks More Competition

FCC Chairman Wiley told NATPE registrants that after nearly 7 years on the Federal Communications Commission, he was preparing to step down but in no way expected to end his interest in

continued on page 58



These four men head successful locally produced programs at their stations: (standing, left to right) Bob Lewis, KGCO-TV, Portland, Bill Hillier, KPIX, San Francisco; (Seated, left to right) Irwin Starr, WMAL-TV, Washington, Dave Fox, KCRA-TV, Sacramento.

NATPE's Leadership: (left to right) Jim Majors, WIBK-TV, Detroit, president; NATPE; Jack Jacobson, WGN, Chicago, 2nd vice president; Betty Woodland, executive secretary; Phil Boyer, WLS-TV, Chicago, immediate past president; and A.R. Van Cantfort, WSB-TV, Atlanta, 1st vice president.



broadcasting.

Regarding the recently launched study of network-affiliate relationships, Wiley said that it was "to determine whether any practices of the networks are improperly restricting such discretion (of the individually licensed broadcaster to exercise programming judgement)." Government does have a proper role in regulating the activities and practices of the commercial television industry, said Wiley, "and it seems to me that the government's responsibility then is to insure that com-

petition has a real chance to operate and to produce diversity, choice, and innovation in the public interest."

Wiley warned, perhaps for the benefit of his successor, that too many good intentioned people were asking government to step into "sensitive first amendment areas" in terms of programming when this would best be left to the marketplace. "I think," said Wiley, "it is imperative that responsible public officials have the courage and foresight to say 'No' to proposals on which an affirmative answer would

tend to undermine the basic principles which support a free society."

Networks and Indies Hold Meetings At NATPE

In addition to the other activities at the NATPE conference, the networks met with their affiliates in separate meetings as did independents.

At the ABC meeting, Fred Silverman, president of ABC Entertainment, played to a group of happy local programming executives pleased with ratings and the kudos received for "Roots." Silverman indicated that ABC was working on about 55 new projects, some of which would use the strip approach so nicely demonstrated by "Roots." The director of "Roots" was now engaged in a new project about an 18 year old boy raised in the jungle who suddenly finds himself back in the civilized world. Also in the lineup is "Future Cop," a show starring Ernest Borgnine; a biography of the Eisenhower years and a presentation of John Erlichman's spy thriller for television starring Cliff Robertson. ABC also plans the first prime time sci-fi show since "Star Trek." The question to which everyone already had the answer was will there be a sequel to "Roots" and, of course, the answer was "most probably."

NBC's affiliates were a bit uncomfortable with the money the net-

continued on page 60

Your Smaller Market = Our Bigger Market.

In this "Year of the Computer", many are talking about business automation in smaller markets. That's the time to consult PSI! We're the international leaders in computer systems for broadcasting, and many of our installations are in so-called "smaller" stations and communities.

You see, our Systems are not just trimmed-down major-market "availability" or "traffic" systems. Our "BAT" Billing, Accounting, and Traffic Systems do the whole job. They do Payroll. Print all reports, from the log to the P&L and Balance Sheet. Handle Accounts Receivable Aging. Invoicing. Sales reports. Interface to your program automation. And more. For radio and/or TV.

BAT Systems use a modern minicomputer. No phone lines to pay for, no leases forever. System support is the best in the industry, available in small towns and big cities worldwide.

The results: *Small-market cost. Large-market performance.*

It might surprise you that such a System could fit into your operation and pay for itself — and you can determine this with no cost. Have us do a free

"Station System Analysis" at your facility. We'll examine your needs, and evaluate your present procedures. Odds are, one of our BAT System models will be the right size and cost for your situation. You'll be getting more information, better control, more accuracy, less dependence on "critical" employees. You'll make more money as a result. To let you verify our conclusions, we'll give you a list of other stations like yours which use BAT Systems.

You'll discover *there's a BAT System designed with your "small market" in mind!*

For more details, or your free analysis, call or write Jim Lang, Director of Marketing, PAPERWORK SYSTEMS, INC., P.O. Box 38, 1609 Broadway, Bellingham, Washington 98225. Call toll free (800) 426-8872. In Alaska, Hawaii, Washington State or outside the U.S., call (206) 733-8510 collect.

Sooner or Later
we'll be
in your office!



PSI®

Q: Why do ENG cameramen wear Frezzi-Belts™?

A: To keep their hand-held video cameras from running down!



“Shoot all day without the need of any external power source.” **Frezzi-Belt™ battery packs** will run your **RCA TK-76**, or **Ikegami HL-77** or **37**, or **Hitachi * SK-80** (and others) about **3 hours**, or power **Sun Gun** or **Mini-Pro** lights. Up to 5 belts recharge automatically (hands-off) on **Frezzi Sequencer Charger**, in sequence. For information: **(New Jersey 201) 427-1160** or **(New York 212) 594-2294**.

** Hitachi Belt available only from Hitachi Denshi America, Ltd.*

Frezzolini™ E.N.G. support equipment.



Frezzolini Electronics Inc.

7 Valley St. Hawthorne, N.J. 07506 USA

Circle 136 on Reader Service Card

MADE IN U.S.A.

NATPE Conference

work laid out for the Olympics but most felt better that they'd be carrying it rather than the competition. Daytime Gothic novels were cited as possibilities for the near future along with the numerous prime time novels NBC bought from MCA-TV. The fact that frequently as many as 60 percent of NBC's affiliates would not clear "Weekend" on a new 6 o'clock Sunday evening slot obviously caused the network some consternation. "Chico and the Man" will probably surface next season with a child in a

new role but any hope for spin-offs had to be put off for a while.

One prospect that was brought up to everyone's puzzlement was a reported effort to sign President Carter for a one shot Saturday morning kids show with a historical bent. Contact by NBC had allegedly been made prior to the inauguration and no definite reaction had been received. There was indication, according to an NBC spokesman, that he "might do it." This news was greeted with some incredulity.

The Independents meeting began with a proscription against questions regarding Metronet, the Olgilvy &

Mather inspired venture now being handled by Metromedia. According to information supplied at a previous press conference, Olgilvy & Mather had handed all responsibility for Metromet over to the Metromedia people. The Independent meeting became a confrontation between the stations and the panel of advertising agency people assembled.

The agencies represented were J. Walter Thompson, Benton & Bowles, and Olgilvy & Mather, all now in the program syndication business. When asked why agencies had become involved in syndication, Howard Eaton of O&M, pointed out that this was not a new trend. O&M had syndicated "This Is Your Life" and "Lassie" for many years, largely at the request of advertising clients.

What was a new trend and seemed to have the Indies concerned, was the increase in the number of barter programs being marketed and questions of whether money allocated for so-called 4th market efforts would come from client's network budgets or spot budgets.

Eaton pointed out that the new efforts were inspired by the tightness of network availabilities and that the money would come from network budgets "if we can get anything comparable to network clearance." The question of suitable clearance said "Bucky" Buchanan of JWT, depended on what the client called suitable. For some, he said, 50 or 60 percent is viable. "The cost of production," said Buchanan, "that some of us have saddled ourselves with" is the cause, in part, for higher clearances, up to 70 percent.

The Operation Prime Time (OPT) venture which reportedly was calling for \$55,000 for a 30 second spot dropped that price during the convention to \$40,000. According to Al Masini of TeleRep, which is handling national sales for the OPT project, this action was not a "price cut" but an adjustment. The original package called for two exposures on a network affiliate in prime time and two exposures on an independent in fringe time. A large portion of affiliates preferred only one exposure so that OPT is now in the position of offering a client one affiliate prime time exposure with a projected 18 rating and two independent fringe time exposures with a projected 18 rating.

One other major concern voiced by the independents over the increasing involvement of agencies in programming was that agencies may tend to bid up the price of syndicated material on behalf of clients seeking suitable vehicles. Small market stations may be forced to accept barter deals from these agencies in order to get high quality programs snatched up through agency buying power.

HOW TO PUT A PROFESSIONAL STEREO RECORDER TO WORK IN YOUR STUDIO FOR ONLY \$76.65 A MONTH



Lease a 750 Series Stereo Recorder/Reproducer from International Tapetronics. Pay for your equipment as it pays for itself. Mono Recorders available at only \$66.50 a month.

Give us a call on our Toll-Free number and we'll tell you all about our three-year warranty, standard with all leases.

800-447-0414 TOLL-FREE

309-828-1381 COLLECT in Alaska, Hawaii and Illinois



INTERNATIONAL TAPETRONICS CORPORATION

2425 SOUTH MAIN STREET • BLOOMINGTON, ILLINOIS 61701

Marketed exclusively in Canada by McCurdy
Radio Industries Ltd. Toronto

Circle 137 on Reader Service Card

20 20

Plus

Total Signal Corrector

Corrects time base errors
from any video tape recorder

Automatically positions
VIRS and VITS

Reduces luminance and
color noise by 6dB

Improves horizontal and
vertical picture detail

Reduces cross color errors

Microtime, Inc.
1280 Blue Hills Avenue
Bloomfield, Ct. 06002
(203) 242-4242 TWX 710-425-2390

MICROTIME

Circle 138 on Reader Service Card

INTERPRETING THE **FCC** RULES & REGULATIONS

Licensee-Conducted Contests

By Frederick W. Ford and Lee G. Lovett
Pittman, Lovett, Ford and Hennessey, Washington, D.C.

Broadcasters are turning to contests and promotions in record numbers to boost audience ratings. Although many are modeled on traditional formulations (e.g., cash jackpot contests), a surprisingly large variety of new contest formats have appeared. But, with each new contest format, comes the risk of contravening Commission Rules and policies.

New Rule

For many years, the Commission has maintained policy guidelines for licensee-conducted contests. Recently, the Commission formalized many of these policy guidelines as a Rule:¹

§73.1216 Licensee-conducted contests.—A licensee that broadcasts or advertises information about a contest it conducts shall fully and accurately disclose the material terms of the contest, and shall conduct the contest substantially as announced or advertised. No contest description shall be false, misleading or deceptive with respect to any material term.

The Rule applies to any licensee-conducted contest, which is defined as "a scheme in which a prize is offered or awarded, based upon chance, diligence, knowledge or skill, to members of the public."

The two key phrases of the Rule are (1) "fully and accurately disclose the material terms" and (2) "conduct the contest substantially as announced or advertised." The second sentence is a corollary of the first key phrase.

Disclosure of Material Terms

The Commission considers terms of a contest to be material if the terms (1) "define the operation of the

contest" and (2) "affect participation therein." Most contests will contain the following nine material terms: (1) *How* to enter or participate (2) *Restriction on eligibility* (3) *Entry date* deadlines (4) *Whether* prizes can be won (5) *When* prizes can be won (6) *Nature, extent and value* of prizes (7) *Valuation basis* of prizes (8) *Time and means* of winner selection (9) *Tie-breaking* procedures.

At first glance, it may not always be clear that a contest term is material. For instance, a Washington, D.C. station may develop a cash jackpot contest wherein telephone calls are made asking the party answering to name the current cash jackpot amount to win. If the station uses only the District of Columbia telephone book to randomly choose these people, the station would have to so state as part of the contest rules. This is clearly a restriction on eligibility. Even if the station also used the Suburban Virginia and Maryland telephone books (assuming the station's service area extends into the Washington D.C. suburbs), it would have to state clearly that parties to be called are chosen from these published telephone directories because many people maintain (1) unlisted numbers (available only through directory assistance) or (2) non-published numbers (available only from the party subscribing to telephone service).²

Licensees must disclose material contest terms *beginning* when the station's audience is *first* told how to
continued on page 64

¹Report and Order in Docket No. 20500, 60 FCC 2d 1072, 38 RR 2d 828 (1976).

²It has been estimated that more than 30% of some urban area telephone numbers are unlisted. One method of getting around this problem is to add 2 to the final digit of every third randomly selected published number. This will assure that a significant proportion of unlisted numbers are contacted.

The finest multi-core studio and field camera system ever produced by Philips.

Which means the finest multi-core studio and field camera system ever produced.

In the decade since Philips re-invented color with the Plumbicon® tube, its PC-60 and PC-70 have successively stood as *the* reference standard for broadcast performance. Behind Philips leadership, that standard has steadily improved to today's ultimate—the LDK-25.

That Philips has again leapfrogged the competition can surprise no one who knows broadcast cameras...since we created Plumbicon® technology. After a decade of refinement and improvement Philips is still the *only* company that manufactures all of the critical picture determining components—computer-matched yokes, beam splitting prism, deflection circuitry and Plumbicon® tubes. The *only* company that can design each component for optimum performance of the entire camera system. These advantages, of superior Philips design and in-house component availability, offer you unsurpassed stability, picture quality and value.

Further, at Philips, we offer you options that *are* options. The LDK-25 you buy is a custom unit, equipped

with the automatic features you select...not a 'loaded' factory package.

But you can't just read about the LDK-25...you've got to experience it.

Only a demonstration can show you how our anti-comet-tail Plumbicon® tubes handle highlights up to 32x normal peak-white level without blooming or streaking—and without loss of our famous color rendition and resolution. 'Live' is the only way to learn what our Color Line-Up Equipment (CLUE) can do for ease of balance... what electronic color temperature control, auto white balance, flexible auto iris and contrast compression mean in use.

Only after you've seen it all—after you've actually handled this remarkable camera—will you understand why the Philips name is a guarantee of incomparable stability...why no one else can match our 1000-hour performance.

To get your hands on an LDK-25 or to get more information, call us today at (201) 529-3800, or write: Philips Broadcast Equipment Corp., 91 McKee Drive, Mahwah, N.J. 07430.

the
INNOVISION
company*



PHILIPS®
TM N.V. Philips

Innovative Leader in World Television

Circle 139 on Reader Service Card for literature
Circle 140 on Reader Service Card for a demonstration

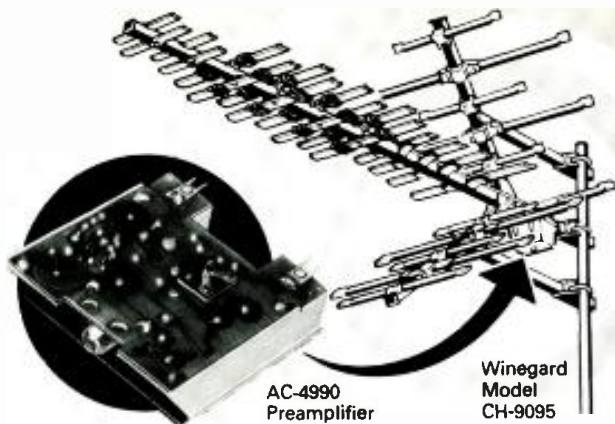

AC-4990
Preamplifier

Winegard
Model
CH-9095

UHF Station Managers and Chief Engineers...

This remarkable low-noise preamp and new antenna make poor UHF pictures good, and fair UHF pictures excellent.

You might have read about the new Winegard AC-4990 preamplifier combined with the Winegard CH-9095 antenna, in the "UHF Equality" article in the November, 1976 BROADCAST MANAGEMENT/ENGINEERING. The article stated:

"CUB (Council for UHF Broadcasting) members who have tried the new combination say that it has excellent characteristics. It seems to be another worthwhile aid to the improvement of UHF broadcasting. It seems likely that many UHF fringe-area viewers will be willing to make the fairly large investment—\$65.95 list for the antenna and \$78.50 list for the preamplifier—for what will give them in many cases a very substantial improvement, lifting them out of the "fringe" category."

Actual home installations, presently in use, have brought about significant results with good reception of UHF stations extended up to 30 additional miles, nearly doubling the stations' effective range.

This means that TV households barely receiving you can now get good, watchable pictures. Those with only fair reception can now get excellent reception.

We want you to know about these extraordinary Winegard UHF reception products so you can help your viewers improve their reception while increasing your audience and reach.

If you would like more information and a copy of our "UHF Tips" booklet, please write us on your letterhead.



WINEGARD
The Winegard Company

Dept. UHF, 3000 Kirkwood Street, Burlington, Iowa 52601

Circle 141 on Reader Service Card

FCC Rules & Regs

enter the contest. (This does *not* apply to pre-contest announcements designed to spark listener interest, such as "The WZZZ Jackpot Money Contest is coming on April 10th. You could win up to \$500.") Material terms must also be disclosed during each *subsequent* time that the audience is told *how* to enter, but not every time that a mention of the contest is made. This does not mean that a station may announce how to enter a contest (and disclose the other material terms) only once per week. Rather, material terms must be disclosed a "reasonable number" of times. This amorphous guideline has not yet been sufficiently clarified by the Commission. Licensees should consult with their communications counsel to determine how often material terms should be announced. Finally, a licensee is free to use other broadcast and print media to disseminate material contest terms as a supplement to dissemination on its own station.

Conduct Contest as Announced

Once a station has fully and accurately disclosed the material terms of a contest, the station has a recognized duty to conduct the program as announced. To do otherwise is tantamount to deceiving the audience and falls short of the licensee's duty to operate in the public interest.

An example illustrates how easy it can be to violate this requirement. Assume that WZZZ is conducting a Money Jackpot Contest. The station's material terms announcements state that (1) the jackpot will be increased by \$10 each time that a randomly called party cannot identify the jackpot amount and (2) one call will be made every hour. Assume, further, that the station personnel take it upon themselves to make several calls per hour (and to raise the jackpot amount when an incorrect guess is made) when no winners occur over the period of a few hours to "generate action." This constitutes a failure of the station to conduct the contest as announced. Listeners would likely rely upon the statement that *one* call would be made per hour when guessing the jackpot amount (e.g., they would assume that the jackpot could only increase \$10 per hour).

Other examples include (1) "urging participation in a contest, or urging persons to stay tuned to the station in order to win, at times when it is not possible to win prizes," (2) failing to award prizes (promptly, or even at all), (3) changing contest rules or conditions without *promptly* advising the public, and (4) using arbitrary or inconsistently applied standards in judging contest entries.

Exempted Contests

Section 73.1216 of the Commission's Rules does *not* apply to several different types of contests including:

- (1) Contests not broadcast or advertised to all or a substantial segment of the general public;
- (2) Contests in which the general public is *not permitted* or *not requested* to participate;
- (3) Advertisements of contests conducted by parties other than the licensee; (e.g., advertisers); or
- (4) Contests conducted by a non-broadcast division of a licensee.

Contests at Variance with the Public Interest

For more than a decade, the Commission has warned licensees about contests and promotional schemes which adversely affect the public interest because of the results that they produce. For instance, "treasure hunt" games have resulted in thousands of dollars in damage caused by contestants who literally ransacked public buildings

FCC Rules & Regs

searching for the prize. One contest offered a prize to the first listener who arrived at a designated location. The resulting "stampede" caused serious traffic jams and extremely dangerous driving conditions.

When a station formulates a contest, careful consideration should be given to the possibility of any of the following adverse consequences: (1) "Infringement of public or private property rights or the right of privacy"; (2) "alarm to the public about imaginary dangers"; (3) "annoyance or embarrassment to innocent parties"; (4) "hazards to life and health"; (5) "traffic congestion or other public disorder requiring diversion of police from other duties."

Lotteries

In addition to disclosing material terms of the contest, conducting it as advertised and avoiding adverse consequences, a station must avoid conducting a lottery.

A program or advertisement is considered a lottery when:

... a prize consisting of money or other thing of value is awarded to any person whose selection is dependent in whole or in part upon lot or chance, if as a condition of winning or competing for such prize, such winner or winners are required to furnish any money or other thing of value or are required to have in their possession any product sold, manufactured, furnished or distributed by a sponsor of a program broadcast on the station in question.³

Recently, a half dozen Washington, D.C. stations were assessed forfeitures ranging from \$2,000 to \$3,000 for broadcasting an advertisement that constituted a lottery.⁴ A clothing store chain advertised that customers purchasing pants could win a discount by spinning a wheel at the sales counter. Commission personnel visited several stores and ascertained that customers were required to commit to purchase a pair of pants before being permitted to spin the wheel. All the elements of a lottery were present: (1) awarding of a prize (a discount), (2) upon a contingency determined by chance (a spin of the wheel), (3) to a person who has paid or agreed to pay for a chance to win the prize (customers had to agree to buy a pair of pants).

The stations complained that they had exercised reasonable diligence by securing outside assurances that the advertisement was not a lottery. The Commission found otherwise, noting that *no calls or visits to the stores were made by station personnel to determine whether or not a lottery was taking place.*

This is a stringent standard! Licensees should take special pains to screen programs and advertisements for lotteries in the future.

Sanctions

Sanctions for violation of the licensee-conducted contest rule and the lottery rule run from termination of operating authority, to short term renewal, to forfeiture, to a letter of admonition. The Commission often views infraction of these rules as raising serious questions concerning whether a licensee has fallen short of operating in the public interest.

A licensee should take special care to thoroughly instruct station personnel concerning licensee-conducted contests and lotteries. The Commission has, and will, hold a licensee responsible for the actions of its employees even though the licensee had no knowledge of the offending program or advertisement. **BM/E**

³Section 73.1211 of the Commission's Rules.

⁴*In re Metromedia, Inc., et al.*, 60 FCC 2d 1075, 38 RR 2d 785 (1976).

for THE VERY BEST STEREO SOUND

The Very Best FM Exciter Wilkinson Model FME10

253 TRANSMITTERS USE IT!
POSITIVE PROOF!

- * Frequency response $\pm 1/4$ DB 15 HZ-350KHz.
- * FM Noise Level — 70 DB below 100% Mod.
- * Distortion — 0.3%
- * Power Output — Adjustable to 18 watts.
- * Stability 1 part in 100,000.
- * Requires no oven and is not susceptible to rumble and microphonics.



FCC Type Accepted

- POWER SUPPLY INCLUDED.
- COMPLETELY METERED.
- REQUIRES 7" VERT. SPACE.
- ADJUSTMENT FREE.

The Very Best Stereo Generator Wilkinson Model SG1E

196 TRANSMITTERS USE IT!
POSITIVE PROOF!

- * 60 db separation 50 Hz-7500 Hz
- * 55 db separation 7500 Hz-10000 Hz
- * 50 db separation 10 KHz 15 KHz
- * FM Noise — 75 db Cross Talk — 60 db



COMES COMPLETE WITH POWER SUPPLY
REQUIRES ONLY 3 1/2" RACK SPACE
ONLY ONE FRONT PANEL ADJUSTMENT
REMOTE STEREO ON/OFF FUNCTION

NO ONE CAN MATCH THIS COMBINATION

WILKINSON

ELECTRONICS, INC.

P.O. Box 738 • Trainer, Pa. 19013
Telephone [215] 497-5100

Circle 142 on Reader Service Card

charges through the relay coil, causing the relay to pull in and latch, with holding current flowing through the relay coil and R1. C now completely discharges through R2; when S1 is again pressed, C is reconnected in parallel with the relay coil. Discharged this time, it represents a short, and causes the relay to drop out, returning the circuit to the original condition.

8. Calculator Program For Time Addition And Subtraction On Videotape Editors.

Milan Merhar, Engineer, WGBH-TV, Boston, MA

Problem: To set up a program on the Hewlett-Packard HP-25 calculator to display time duration, sums and differences from SMPTE time code data.

Solution: With the increasing use of automation systems for tape editing, SMPTE timecode data is becoming more common. This not only means that calculation involving frames is necessary but that some method of calculating the actual running time of tapes using non-drop frame timecode is needed.

This program, used with a Hewlett

To add:	Input Data	Keys	Displayed Data
1. Enter the first value (start time)	1st H.MSF	R/S	0.000000
2a. Enter the second value (duration) to get End time as a result.	2nd H.MSF	R/S	H.MSF (flashes once)

You may reenter this result as a new first value by pressing R/S and continuing at step 2a or 2b with the new second value.

You may start a new calculation by returning to step 1.

To Subtract:	Input Data	Keys	Displayed Data
1. Enter the first value (end time)	1st H.MSF	R/S	0.000000
2b. Enter the second value (start time) to get duration as a result.	2nd H.MSF	CHS/R/S	H.MSF (flashes once)

You may reenter this result as a new first value by pressing R/S and continuing at step 2a or 2b with a new second value.

You may start a new calculation by returning to step 1.

Mehar's program on the Hewlett-Packard HP-25 calculator.

Packard HP-25 calculator, accepts two hour, minute, second, frame values and calculates their sum or difference. SMPTE drop frame timecode or "clock" times are accepted directly; changing a constant allows the calculation of actual durations from non-drop frame timecode data.

To set up the calculator, enter the program as listed; store the listed

values in the storage registers; and, in run mode, press GTO 00. Set the display to FIX 6 to view the full time or to FIX 4 if frame data is not needed.

If you are using non-drop frame SMPTE timecode data and wish to convert the calculations into actual running times, change the constant in register four from 1.00 to 0.9990.

continued on page 68

OKAY, YOU ASKED FOR IT AND GRANDSON HAS IT

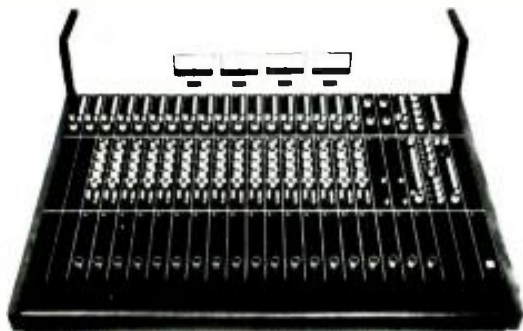

"It" is more. That's what broadcasters have been asking for in production consoles. Flexibility. Capability. And totally unique Grandson has it all.

There is nothing else like it anywhere!

Equalization at each input position. Don't laugh. If you don't think it's needed, that's because you haven't tried it. EQ is only the most useful, creative tool in audio. And Grandson's EQ is something special. One major network has bought a bunch. That's special.

Monitoring and foldback flexibility to let you and the talent have separate monitor mixes! And changes of monitor mode at the push of a single button. Here's the key to fast, creative production.

Internal patch point, after mic preamp before fader, brought out to permit inserting special devices. How about plugging in a limiter just ahead of the pot for the screamer, or mic swallower. Think that would be neat? So do we. Grandson will let you do it!

Four reasons Grandson was selected by ABC-TV, Hughes Sports Network and WWL in the Superdome. There are more. None accidental. Because you said it's needed.

Grandson is "it." A totally unique approach. Want more details? Write or phone today.

 **audiotronics, inc.**

P.O. Box 12637 Memphis, Tn. 38112 901-276-6338

The closer you look, the better we look.

Great Ideas

(Remember to change this constant back before returning to normal calculations.)

Times are entered and displayed in the form H.MSF where H = hours from 00 to 23, M = minutes from 00 to 59, S = seconds from 00 to 59, and F = frames from 00 to 29. As in a normal decimal number, unnecessary leading or trailing zeroes need not be entered.

9. Muting Cue Channel Without Additional Power Load

Steve Bridges, Chief Engineer, KYKX-FM, Longview, Texas

Problem: To mute the cue channel on the Sparta AS-40B console without adding to the load on the mute or console power supply.

Solution: The mike mute relay is external to the console and enters on the rear apron. This entry point is at -34 volts when the mike switch is off, at ground when it's on. This voltage is

THE HP-25 OR HP-25C TIME CALCULATIONS

STEP	KEY ENTRY	CODE SHOWN	COMMENTS	KEY ENTRY	CODE SHOWN	COMMENTS	REGISTERS
01	RCL 7	24 07	START OF PROGRAM				R1 SCALAR
02	X	61	M.M.S.F.				R2 INT VISE
03	ENTER	71				STAGE PROGRAM NOT LISTED	
04	g FACT	15 01	.F			DESIGNABLE REGISTERS 0,3,4,5,6,7	
05	RCL 6	24 08				ON NUMBERS SHOWN	
06	+	71					
07	RCL 7	24 07					
08	F INT	24 01	M.M.S.F.			SWITCH TO NEW MODE	R3 CONSTANT
09	+	51	M.M.S.F.			ROUND GET GO	S=10 ⁻⁶
10	RCL 7	24 07	M.M.S.F.			SET DISPLAY TO FIX 6	R4 CONSTANT
11	+	71				(FIX 4 FOR DISPLAYED EXAMPLE)	1.00
12	g H	15 00	M.M.S.F.				(FIX 0.00)
13	RCL 0	24 00	H				R5 CONSTANT
14	g X 0 0	19 71	ROUND VIA INTERNAL PROCESS			MINUS	24.0
15	RCL 3	13 21	GET 3 LINES AND PRINT			CHANGE THE CONSTANT IN	
16	RCL 6	24 08				EQUATION 4 TO 9.9990 IN	
17	g H	15 01	M.M.S.F.			GET 2ND AND INPUT UNIT	R6 CONSTANT
18	g H	15 01	M.M.S.F.			PRINT 2ND LINE	0.3
19	g H	15 01	M.M.S.F.			PRINT 3RD LINE	
20	g H	15 01	M.M.S.F.			PRINT 4TH LINE	R7 CONSTANT
21	g H	15 01	M.M.S.F.			PRINT 5TH LINE	1.00
22	g H	15 01	M.M.S.F.			PRINT 6TH LINE	
23	g H	15 01	M.M.S.F.			PRINT 7TH LINE	
24	g H	15 01	M.M.S.F.			PRINT 8TH LINE	
25	g H	15 01	M.M.S.F.			PRINT 9TH LINE	
26	RCL 4	24 04	ROUND UP CONSTANT			ACTUAL RUNNING TIME	R8 FLAG
27	+	71				FULLSCALE USE WITH "CEC"	(SET 1)
28	RCL 1	24 01				TIME OR TIMEBASE DATA	(SEE SCALING)
29	+	51				BASELINE SHOULD BE SET TO	0.0
30	RCL 3	24 03	ROUND UP CONSTANT			1.00 AS SHOWN	
31	+	51					
32	F MMS	14 01	M.M.S.F.				
33	RCL 7	24 07	M.M.S.F.				
34	X	61					
35	ENTER	71					
36	g FACT	15 01	.F				
37	RCL 6	24 08					
38	+	61	.F				
39	X	61	M.M.S.F.				
40	F INT	14 01	M.M.S.F.				
41	+	51	M.M.S.F.				
42	RCL 7	24 07	M.M.S.F.				
43	+	71					
44	RCL 5	13 05	M.M.S.F.				
45	g H	15 00	SET FLAG				
46	F MMS	14 01	M.M.S.F.				
47	RCL 4	24 04	ROUND UP CONSTANT				
48	+	71					
49	g H	15 00	SET FLAG				
50	g H	15 00	SET FLAG				
51	g H	15 00	SET FLAG				
52	g H	15 00	SET FLAG				
53	g H	15 00	SET FLAG				
54	g H	15 00	SET FLAG				
55	g H	15 00	SET FLAG				
56	g H	15 00	SET FLAG				
57	g H	15 00	SET FLAG				
58	g H	15 00	SET FLAG				
59	g H	15 00	SET FLAG				
60	g H	15 00	SET FLAG				
61	g H	15 00	SET FLAG				
62	g H	15 00	SET FLAG				
63	g H	15 00	SET FLAG				
64	g H	15 00	SET FLAG				
65	g H	15 00	SET FLAG				
66	g H	15 00	SET FLAG				
67	g H	15 00	SET FLAG				
68	g H	15 00	SET FLAG				
69	g H	15 00	SET FLAG				
70	g H	15 00	SET FLAG				
71	g H	15 00	SET FLAG				
72	g H	15 00	SET FLAG				
73	g H	15 00	SET FLAG				
74	g H	15 00	SET FLAG				
75	g H	15 00	SET FLAG				
76	g H	15 00	SET FLAG				
77	g H	15 00	SET FLAG				
78	g H	15 00	SET FLAG				
79	g H	15 00	SET FLAG				
80	g H	15 00	SET FLAG				
81	g H	15 00	SET FLAG				
82	g H	15 00	SET FLAG				
83	g H	15 00	SET FLAG				
84	g H	15 00	SET FLAG				
85	g H	15 00	SET FLAG				
86	g H	15 00	SET FLAG				
87	g H	15 00	SET FLAG				
88	g H	15 00	SET FLAG				
89	g H	15 00	SET FLAG				
90	g H	15 00	SET FLAG				
91	g H	15 00	SET FLAG				
92	g H	15 00	SET FLAG				
93	g H	15 00	SET FLAG				
94	g H	15 00	SET FLAG				
95	g H	15 00	SET FLAG				
96	g H	15 00	SET FLAG				
97	g H	15 00	SET FLAG				
98	g H	15 00	SET FLAG				
99	g H	15 00	SET FLAG				
100	g H	15 00	SET FLAG				

HP-25 or HP-25c time calculations by Mehar.

It's the right time to try the new Leitch Precision Impulse Clock featuring Videglo.*

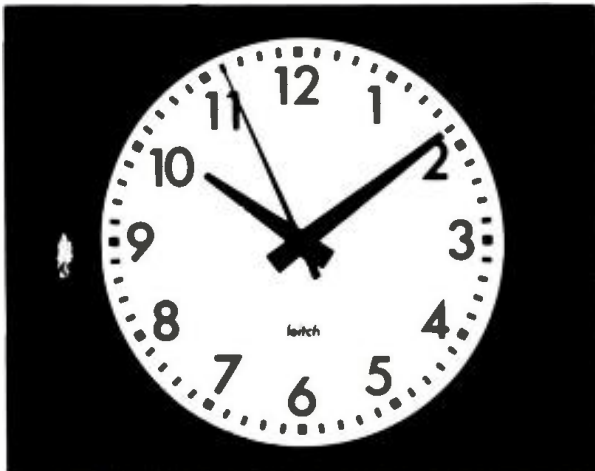

The Leitch Precision Impulse Clock has been developed by the craftsmen at Leitch Broadcast Products Limited to provide accurate time for broadcasters who demand precision time control with cool illumination. It will not upset the carefully controlled lighting of control room equipment.

Each clock is equipped with Leitch's "Videglo" self illumination system that brightens the clock face without spilling over light into the control room.

Silent operation, compatibility with existing impulse master clock systems, American servicing and clean, attractive lines are just a few of the reasons for switching to Leitch.

Contact our representatives for a free trial. Your Leitch Precision Impulse Clock will be on its way to you in a matter of days.

Clocks are available in a full range of sizes; diameters measure 16", 12", 8" and 5 1/2" (console mount).

Exclusive U.S. distributor:
leitch video incorporated
 230 Mineola Blvd.,
 Mineola, New York 11501.
 Tel: (516) 248-4858.

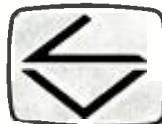

In Canada:
leitch broadcast products limited
 705 Progress Avenue
 Scarborough, Ontario M1H 2X1
 Tel: (416) 438-5060. Telex: 06-23604.

used to control transistor Q1 which serves as an inverter. Q1 controls the gate voltage via R3; this switches Q2 and therefore the audio.

R3 is connected to -27 volts at pin 1 on the cue amp card. Remove the white wire from pin 2 on the cue card and connect it to the 1 uf cap. Connect the junction of Q2, R2 also pin 2 of the cue card.

Q1 may be any general purpose PNP transistor with Vce better than 35 volts. Q2 is an audio N-channel FET. C1 should be nonpolaris. Total current is 3.4 ma. All parts were mounted on a small piece of perf board that was mounted to the cue card.

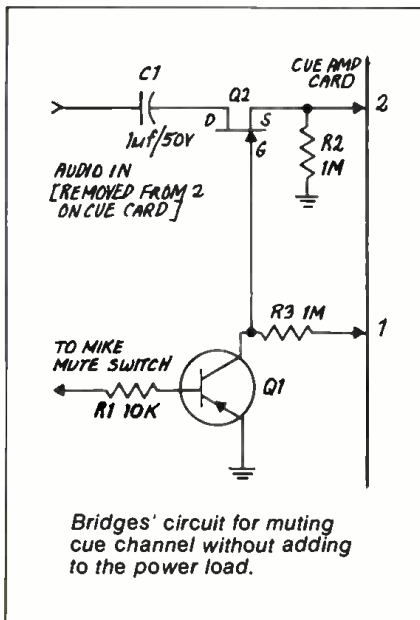

10. Synchronizing The ENG Remote Without Studio Genlocking.

Gerard Mullin, Technician, WJBK-TV, Southfield, MI

Problem: To synchronize various modes of ENG and remote pickup in a direct way.

Solution: Use the TBC, timed to the studio switcher, to correct for horizontal and color errors; have the remote V(vertical) referenced to the studio by using the station's "AIR" signal.

For VTR playbacks at the remote site (for "AIR" or dub to studio quad), the Sony VO-2850 is V referenced by switching the "INPUT SELECT" to "TV," and tuning to the Station's "AIR" signal.

For live ENG, V reference is attained by either continuously (hard lock) or momentarily (soft lock) genlocking the camera to the "AIR" signal via the "TV OUT" of the 2850. V coincidence is ascertained by the ab-

sence of the V blanking bar from the observed active video at the output of the TBC. There is a one line delay for every 6 miles of studio to remote separation; it can be compensated for by advancing the "V PHASE" of the hard-locked generator. When soft locked, the remote should zero beat its 3.58 against the studio's, for long term V coincidence. (The 2850 is free to V-reference to the camera by switching the "INPUT SELECT" to "LINE.")

The studio should habitually be in V-phase with network (via soft lock),

so that the remote may freely V-reference at anytime. (A byproduct is that the network now becomes synchronous when taken thru the TBC.)

The "AIR" signal is not essential; the studio can "talk" the remote into V coincidence by having the remote continuously interrupt its sync generator (e.g., make and break the genlock switch) until the studio confirms V coincidence.

Finally, for live ENG only, a VTR buffer in "EE" can be used as a frame synchronizer in the same manner as a TBC.

What's so special about Beaucart stereo machines?

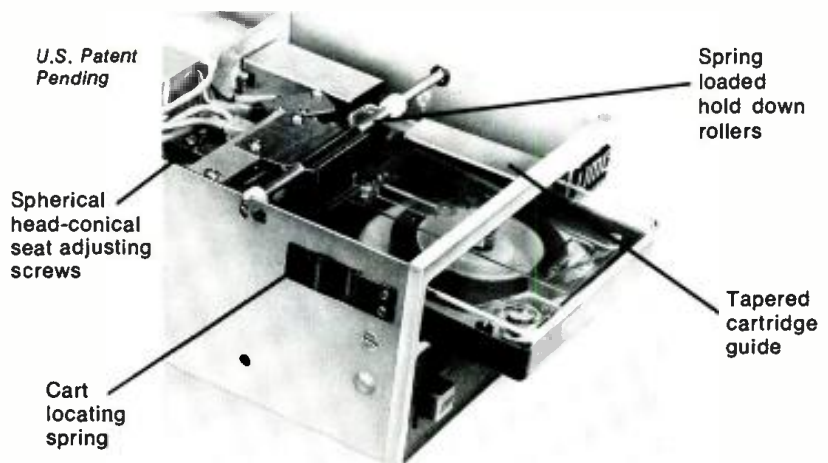

Everything.

Don't let anybody tell you that all stereo broadcast cart machines are the same. It just isn't so. Because we've built into our Beaucart stereo units proprietary cartridge locating features which enhance stereo phasing from cartridge to cartridge under long term, continuous service conditions.

Take a look at the photo. No other machine incorporates these features. Our spring-loaded rollers ensure repeatable location of each cart's left corner post. The tapered cartridge guide allows each cart to squarely contact the roller and feed smoothly into the machine. Our locating spring positions the cart against the right-hand guide every time, and our unique ad-

justing screws for which patents have been applied provide uniform, positive contact immune to movement from external forces.

Little things? Sure! There are a hundred little things that make full-featured Beaucart the stereo machine for you.

Let us tell you more. Write or call today for further details and pricing. You'll be glad you did!

UMC

BEAUCART DIVISION
UMC ELECTRONICS CO.

460 Sackett Point Rd. North Haven, CT 06473 (203) 288-7731

Circle 145 on Reader Service Card

Spotmaster®

A BIG SELECTION FOR A SMALL BUDGET

If you are trying to fit a cart-ridge machine into a budget, you may think you have a limited choice of machines.

With Spotmaster this isn't true. We have many models of economy-priced machines: mono and stereo, record and record/playback, for A, B and C cartridges, delay machines, and a wide choice of options and accessories.

The New 2000 Series



MODEL 2000 RPS — A stereo record/playback machine for only \$975.00. Mono record/playback \$725.00. Mono playback \$500.00

Traditional Favorite

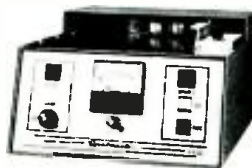

MODEL 500D — Record/Playback Unit. One of twelve 500 Series models, a traditional favorite still in use and still in demand.

Old Faithful



MODEL 405B — Mono Playback Unit. Every time we reduce inventory on the 400 Series, the orders roll in. And why not — at \$495.00 it's an outstanding value.

New Catalog Available

To obtain your copy of the Broadcast Electronics 1977 Audio Equipment Catalog with complete information on 50 models of Spotmaster tape cartridge equipment, write, on your station or company letterhead, to Broadcast Electronics, Inc., 8810 Brookville Rd., Silver Spring, MD 20910, or call 301/587-1800.

BROADCAST ELECTRONICS, INC.
A FILMWAYS COMPANY



Circle 146 on Reader Service Card

BROADCAST

EQUIPMENT

At the head of this month's new products is what may prove to be an important breakthrough in digital video: compact A/D converters for video in a new low price bracket. **BM/E surveyed the fast-advancing digital video field in the February issue and will return to it for a follow up survey in June; and a compact spectrum analyzer for audio signals, forming a complete system for speaker response measurements, room testing, A-B comparisons, microphone and recorder evaluation.**

Video A/D converters 300

Modular, completely self contained video A/D converter takes in high-bandwidth video signals and produces parallel digital format with eight bit accuracy at random or periodic word rates from DC through 11 MHz. Model MATV-8011, 5.5 in. x 4.38 in. x 0.85 in., includes internal 30 ps track-and-hold, encoder, TTL-compatible output data latch, and all required

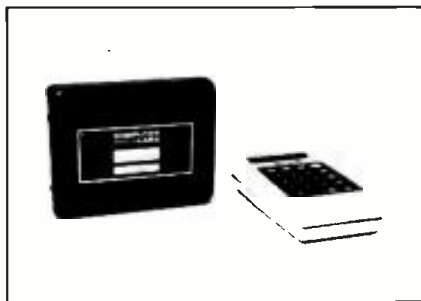

timing. Analog input is 1 volt and 75 ohms. Total power is less than eight watts, with +12V, +5V and -5.2V power supply. Relative accuracy is rated $\pm 0.2\%$ of full scale ($\pm \frac{1}{2}$ LSB); on step function will reach eight-bit accuracy within 50 ns. Also available is the MATV-0808 with essentially the same specs, but limited to 8 MHz encode. MATV-8011, \$1,150; MATV-0808, \$995. COMPUTER LABS. INC.

DC Drive Kit For Sony VTR 301

A direct-drive DC drum servo kit for the Sony VO-2850/2850A replaces the drum drive belt and DC brake with a high-torque DC motor. Installed on the record side of an editing system, it will track out incoming variations, reduce overall timebase error so that a \pm one-line window corrector is adequate. VIDEO ASSOCIATES LABORATORIES.

Audio Spectrum Analyzer 302

Audio spectrum analyzer shows level in each octave to ANSI standards, 20 Hz to 22 kHz with a vertical row of LEDs for each octave. The Model 1000 has two separate memories for "freeze-frame" displays, a pink noise generator with gating, calibrated condenser microphone, mic and line inputs, scope outputs. Column calibrations are available in decibels and SPL units. FET multiplexers, CMOS digital ICs and RAMS are used. \$1300.00 AUDIO DEVELOPMENTS, INC.

Editing Modification, VTR 303

An editing modification for the Sony VO-2600 VTR converts it to full color editing. The AVX-2650 adds the following: rotary erase heads; dual V-lock



servo; vertical interval switching; remote control of editing; a full set of insert editing modes; assemble editing. Modification can be unplugged from VO-2600 at any time. \$3840 (with VTR complete). AVONIX.

Magnetic Pick-Up Tool 304

Permanent magnet on telescoping holder (6 in. to 17 in.) retrieves small parts in tight places, or removes steel dust and chips from drilled or machined metal. MAGNET SALES AND MFG. CO.

Real-Time Spectrum Analyzer 305

Real-time spectrum analyzer has IEEE-488/1975 digital interface, can be run by a minicomputer, terminal or any other programmer/controller using the standard interface. Model FFT 512/S15 allows external device to read from and write into any memory location directly; keyboard instruments such as a graphics display terminal can control completely. Analyzer also has

For more information
circle bold face numbers
on reader service card.

single or dual display, the latter for comparison (of background noise and signal, for example). Also: compatibility with 1/3 octave and full octave filters; cursor readout of absolute and relative amplitudes, frequency, harmonics, sidebands. \$8,900. ROCKLAND SYSTEMS CORP.

Hip Switcher, Portable Color 306

Belt-carried, two-pound switcher allows cameraman to switch, dissolve, superimpose and fade between his own portable video color camera and another up to 100 feet away. The "Color Hip Switcher" does not need an extra sync generator or color phase shifter. Master



camera viewfinder shows either camera image; switching is in vertical interval; built in proc amp insures clean edits. A two-camera edited tape can be produced in field. \$995.00. ANWAR VIDEO CORP.

Polyphonic Adapter 307

New add-on unit for monophonic electronic synthesizers has a one-octave keyboard and digital memory to add chord or pitch combinations to play-

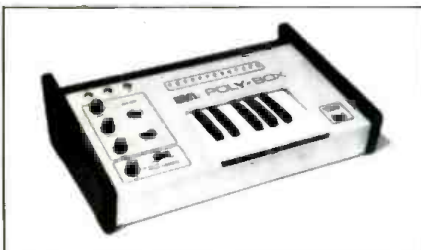

back. The "Poly-Box" memory accepts programming of multi-note combinations which can then be played through the synthesizer. Polyphonic pitches follow synthesizer through portamento, vibrato and keyboard transpositions, one octave above to three octaves below synthesizer. Manual tuning, phasing, low-pass filter
continued on page 72



MARC VII... the DJ's new best friend

It eliminates *all* cartridge handling problems from live studio operation by letting the DJ

- program events in advance.
- view 18 at a time on a CRT screen.
- enter, insert, hold, kill, clear or delete events while on-air.
- control playback from 7 audio inputs—Instacarts, Go-Carts, turntables, reel-to-reel, single plays—name it!

MARC VII is *not* automation—it's a planning device for error-free live radio. KTNT, Tacoma uses and likes it—read about MARC VII in IGM NEWS 1-77. Send for your copy.

IGM

A Division of NTI
4041 Home Road
Bellingham, WA 98225
206-733-4567
See us at the Shoreham
Booth 538

Circle 147 on Reader Service Card

STUDER

PROFESSIONAL
AUDIO
EQUIPMENT

available NOW!

YOUR
POCKET
GUIDE TO
STUDER

Before you buy, let us show you our line of professional audio products. Write or call now for this new brochure describing the complete Studer family. Willi Studer America Inc., 1819 Broadway, Nashville, TN. Phone 615-329-9576. In Canada: Studer Revox Canada Ltd. Phone 416-423-2831.

New! Sylvania Vented FAY Bulb.



- INTERNAL DICHORIC
- HARD COATED
- NO FLAKE OR BURNOFF
- FADING REDUCED
- HEAT SYNC'D & VENTED
- FROSTED INNER CAPSULE
- COOLER OVER LIFE
- MINIMAL LENS CRACKING
- TWO PIECE CONSTRUCTION
- PERFECT RETROFIT

Nationwide service for over 25 years.
Same-day shipment anywhere in US.
(212) JUDSON 6-1620
BARBIZON ELECTRIC
426 W. 55, NYC 10019

Circle 148 on Reader Service Card



Recorder/Reproducer \$790
(Reproducer \$590)

So Much For So Little PD-II SERIES

A machine that records and plays mono tapes in the "A" size cartridge, stops automatically on the 1 kHz cue tone and offers you longer life, less maintenance and better performance than any other cartridge machine at an economy price.

Compare For Yourself

- Quiet air-damped solenoid
- Flat, stable 1/2 inch solid aluminum deck
- Micro-adjustable head assembly
- Direct-drive capstan motor
- Trim design - 3 units fit side-by-side in a 19 inch equipment rack
- Latest solid state components
- Plug-in circuit cards
- No relays

**CALL US AND WE'LL
PROVE IT TO YOU**

For complete information call us collect at 309/828-1381. You'll be talking to experienced broadcasters who not only know what ITC can do—but know what you want it to do.



P.O. Box 241 • 2425 South Main Street
Bloomington, IL. 61701
Marked Exclusively in Canada by
McCurdy Radio Industries Ltd.

Circle 149 on Reader Service Card

New Products

allow bass lines to be played on Poly-Box. \$475.00. ELECTRONIC MUSIC LABORATORIES.

Seven-And-A-Half Digit DVM 309

Digital voltmeter has variable scale length, variable integration time. Model 9577 cover DC from 1 microvolt to 1 kilovolt, AC (rms) from 1 microvolt to 750 volts, resistance from 1 millionohm to 14 megohms; and has DC/DC and DC/AC ratio facilities. For ATE system users, unit has instant start, built-in self check and operating speeds to 500 per second. For accuracy above 5 ppm, measurements can use a longer integration time (above 1 ms). \$3995.00. GUIDELINE INSTRUMENTS, INC.

Storage Reels For Cable 310

Storage for coaxial and microphone cables is simplified by reels with hub slot for beginning, holes in side to hold

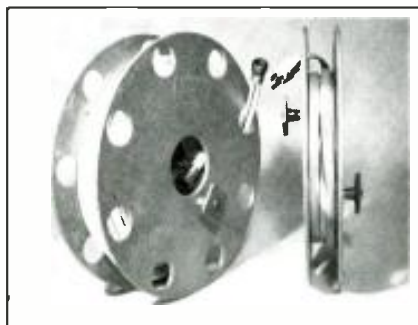

end. The "Spool Tool" holds up to 400 feet of microphone cable or 500 feet of RG-59 coax, stores in 16 in. by 7 1/2 in. Y-BAR SUPPLY CO.

Multilingual Char. Generator 312

Character generator displays scripted texts in mixed Roman and Cyrillic, or almost any other textual characters, including Japanese, from a common character code input. Code is based on 7-bit ISO/ASCII, new international standard. Page has up to 40 horizontal characters and 24 vertical rows. DYNAMIC TECHNOLOGY LTD. (London, UK).

High-Resolution Camera 313

Camera provides up to 1200 lines horizontal and 900 lines corner resolution, with selectable bandwidths up to 32 MHz and scan rates 525 to 1255. Model 7210B has environment-resistant housing for automatic unattended operation with remote control; camera head, in tamper-proof cylindrical housing, can be up to 2000 feet from control unit. COHU, INC.

CATV

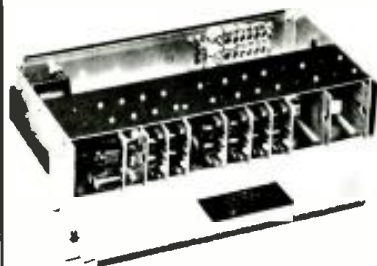

REMOTE CONTROL RECEIVER-SWITCHER

MODEL 3000R-10A
4-FUNCTION \$1095*

*Does your computer
know when a ball game
is going into overtime?*

If not, you need a system as shown above to permit your engineer to take control from his home or office. Switch programs from a dial-up telephone line and/or microwave or radio link.

*Price subject to change without notice.

Write for complete data:



Circle 150 on Reader Service Card

NICKEL CADMIUM ENG. BATTERIES AND ONE HOUR AUTOMATIC CHARGERS

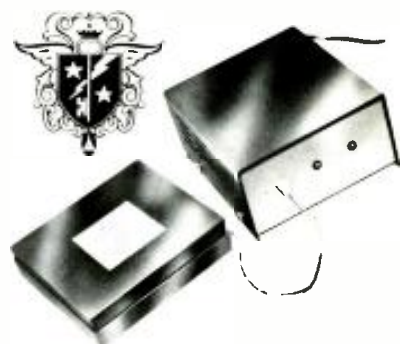

For ALEXANDER Nickel-Cadmium REPLACEMENT BATTERIES For...

SONY (BP20) — JVC (PBP-1)
AKAI (PACK) — etc.

CHARGERS WILL AUTOMATICALLY CHARGE IN 1 TO 4 HRS. DEPENDING ON CAPACITY... (SWITCHES TO TRICKLE)

Write Wire or Phone

ALEXANDER manufacturing co.

Box 1645 Mason City, Iowa 50401
Phone (515) 423-8955

Circle 151 on Reader Service Card

String Instrument Pickup 323

Inertial pickup for string instruments—guitar, bass, banjo, cello, etc.—can be adhered to any point on body, for great variety of tonal qualities, including full sound of instrument. "Amp-tone" is built on an accelerometer, needs no preamplifier, can feed high-level input on hi-fi systems, or professional amplifier. Special cap changes resonance to lift bass. High-end response, to 15 kHz, is based on inertial suspension of ceramic element. DYNA MAGNETIC DEVICES, INC.

Low Cost Power Supply 324

Power supply takes 120 vac input, produces 13.8 vdc at 3 amps. "Quiet Talk" was designed to eliminate load damage from overshoot during switching, and to protect the load device from short circuit damage. Regulation is ±0.3% from no load to full load, ripple under .003 v. CORNELL-DUBILIER ELECTRIC CORP.

Portable Digital Multimeter 325

Low-cost 3½ digit portable multimeter has 200 hour battery life. Model 22 has the five standard modes, reads from 100 microvolts to 1 kilovolt DC. Accuracy is rated 0.1% ± 1 digit on DC. Current measurement is to 20 amps. Readings can be held. Power options are: disposable batteries; rechargeable NiCads; and AC. \$234.00. DATA TECH. DIV. OF PENRIL CORP.

Multi-Channel Peak Meter 326

Up to 28 channels can be indicated (36 in special version) on single CRT screen showing peaks in "bar graph" form. Model 377-100 has color capability, with bar changing to red in overload region. Colors of individual bars can be selected separately for quick identification. Peak indication is according to IEC/DIN. NTP ELECTRONIK (Denmark).

Miniature Monitor Speakers 321

Loudspeaker 6¾ × 4¼ × 4¾ in. handles up to 35 watts continuous power. Braun "Output C" has a long-throw 4 in. woofer, 1 in. dome tweeter, cross-over at 1500 Hz, high frequency response to 25 kHz, low to 50 Hz. \$100. AIXCOM.

For more information circle bold face numbers on reader service card.

Whatever your film chain, EEV can wrap up your Vidicon needs.

We have the tubes you need, when you need them. We can send matched sets—or singles selected for appropriate color channels. Full technical back-up service available. For technical data and details of our very competitive prices, contact us now.

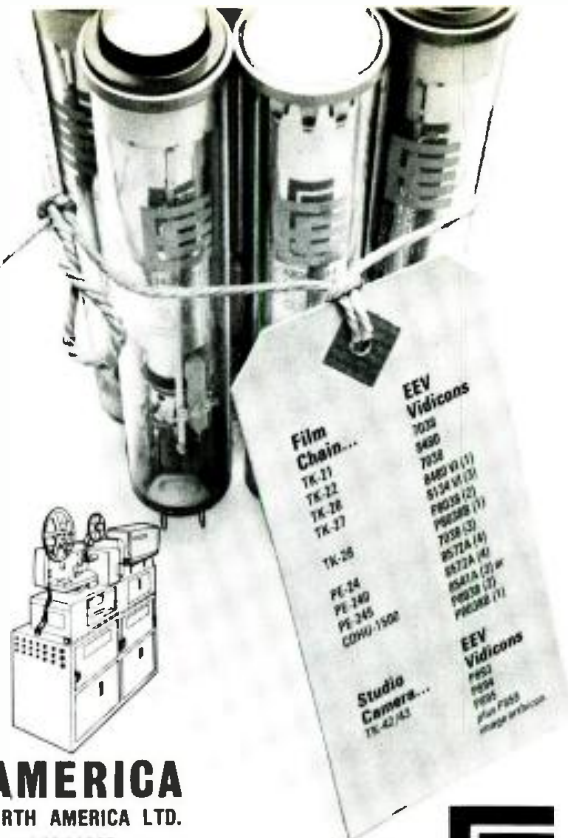

EEV NORTH AMERICA

ENGLISH ELECTRIC VALVE NORTH AMERICA LTD.

1 American Drive • Cheektowaga, NY 14225
(716) 632-5871 • TWX: (710) 523-1862
67 Westmore Drive • Rexdale, Ontario M9V 3Y6
(416) 745-9494 • Telex: 06 965864

A member of the GEC-English Electric Group of Companies



Circle 152 on Reader Service Card

Image Enhancers



(Model 877)

Superior Performance ... Competitive Price ...

- Up to 175% enhancement—highest in the industry
- Horizontal AND vertical balance adjustment
- Typical S/N ration 65–68 dB. 60 dB minimum
- Used by major networks since 1970
- Comb filter for optimum enhancement. no chroma distortion or noise addition
- Models available for automatic or manual enhancement, encoded or RGB inputs, NTSC, PAL, or SECAM

Write or call for Bulletin 459-A

DYNASCIENCES | video products

Township Line Road Blue Bell PA 19422
Tel (215) 643-0250/Telex 84-6358

A SUBSIDIARY OF **Whittaker**

Circle 153 on Reader Service Card

ADVERTISER'S INDEX

Acrodyne Industries, Inc.	12	Fidelipac	18	Philips Audio/Video Systems Corp.	63
Adda Corp.	56	Frezzolini Electronics Inc.	59	Potomac Instruments	16
Alexander Manufacturing Co. ...	72	Grass Valley Group	5	RCA Broadcast Systems ...	30, 31
American Data Corp.	19	Harris Corp.	25, 27, 29	Recortec, Inc.	32
Amperex Electronics Corp.	8	Heller-Oak Communications Finance Corp.	22	Sony Corp. of America	46, 47
Ampex Corp.	Cover 2, 53	IGM, Div. NTI	71	Willi Studer America Inc.	71
Auditronics	67	Ikegami Electronics Inc. ...	54, 55	Tektronix	10, 11, 41
Barbizon Electric	71	International Tapetronics Corp.	60, 72	Tele-Measurements, Inc.	18
Belar Electronics Lab., Inc.	20	LPB, Inc.	16	Telex Communications, Inc. ...	23, 24
Beau Motor Div., UMC Electronics Co.	12, 69	Leitch Video Ltd.	68	Thomson-CSF Labs, Inc.	15
Broadcast Electronics, Inc. .	9, 70	3M/Datavision	13	Time & Frequency Technology Inc.	28
CCA Electronics Corp.	17	Microtime	61	UMC Electronics Co., Beau Motor Div.	12, 69
Canon USA Inc.	3	Monroe Electronics, Inc.	72	Videomagnetics Inc.	43
Central Dynamics Ltd.	35	Pacific Recorders & Engr. Corp.	14	Vital Industries	7
Cetec Broadcast Group	38	Panasonic Matsushita Elec. Corp.	48	Ward-Beck Systems Ltd. .	Cover 4
Dynasciences Video Products .	73	Paperwork Systems, Inc.	58	Wilkinson Electronics, Inc.	65
Eastman Kodak Co.	Cover 3			Winegard Co.	64
English Electric Valve Co.	73				

BROADCAST MARKETING SPECIALISTS

To accommodate a continuing growth pattern, RCA Broadcast Systems is seeking professional specialists in three areas of marketing operations:

BROADCAST SYSTEMS SALES Experience in television station operations and engineering, and/or sales experience in radio, television or related technical fields. BSEE or equivalent is required.

BROADCAST SYSTEMS BID SPECIALISTS To prepare bids and proposals in response to detailed customer specifications and requirements. Good technical knowledge of broadcast and teleproduction studio systems and AM-FM, TV, RF systems. BSEE or equivalent required.

FIELD TECHNICAL SPECIALISTS Experience should cover maintenance and/or operation of cameras, video tape machines or RF products. Technically-oriented specialists willing to travel and expand their knowledge. BS or equivalent required.

Excellent compensation and related employee benefits.

If you qualify, send your resume and salary requirement, in confidence, to: Mr. M.H. Kessler, Mgr. Empl., Dept. *BME-4*, RCA Corporation, Bldg. 3-2, Camden, NJ 08102.

We are an equal opportunity employer F/M.



SENIOR APPLICATIONS ENGINEER

Seeking wider, more challenging outlets for your skills?

We have the right opportunity for you with one of our growing out-of-state divisions . . . provided you're willing to travel and have previously worked in TV systems design. BSEE or equivalent, and a minimum of 5 years experience required, to include a thorough knowledge of TV systems equipment, and a good understanding of the cameras, camera systems and circuitry involved. Knowledge of infrared systems and associated components would be highly desirable.

We offer an excellent salary and complete benefits. For confidential consideration, send resume with salary history and requirement, to: **H.C. ANDERSON**

NORTH AMERICAN PHILIPS CORPORATION

100 East 42nd Street
New York, N.Y. 10017

An equal opportunity employer M/F



A NEW HIGH-SPEED FILM FOR "AVAILABLE DARKNESS."

When the story's there, but the available light isn't so available, load up with new Eastman Ektachrome video news film high speed 7250 (tungsten).

You can shoot where special lighting would be unwelcome or impossible, because you'll have 7250's high speed (EI 400 tungsten) working for you. What's more, you can push development two stops to EI 1600 tungsten with remarkably little increase in grain. Now you can afford to stop down and cover scenes and people with a depth of field and sharpness you may never have thought possible.

This 7250 film is complementary to 7240, and uses the same Process VNF-1 equipment and procedures.

There was a time when "no lights" meant no story. Now it just means you load your camera with this remarkable new film. Get the story in "available darkness."

For a brochure or a call from one of our sales and engineering representatives, please write: Eastman Kodak Company, Dept. 640, Rochester, New York 14650.

FILM IS GOOD NEWS.

Circle 155 on Reader Service Card



A new measure of excellence by Ward-Beck.

Designed for ABC's Studio 57,
Hollywood, the WBS 75056
console features a 32 x 8 x 4
system configuration capable
of handling the most ambitious
TV programs.

Can we create one for you?

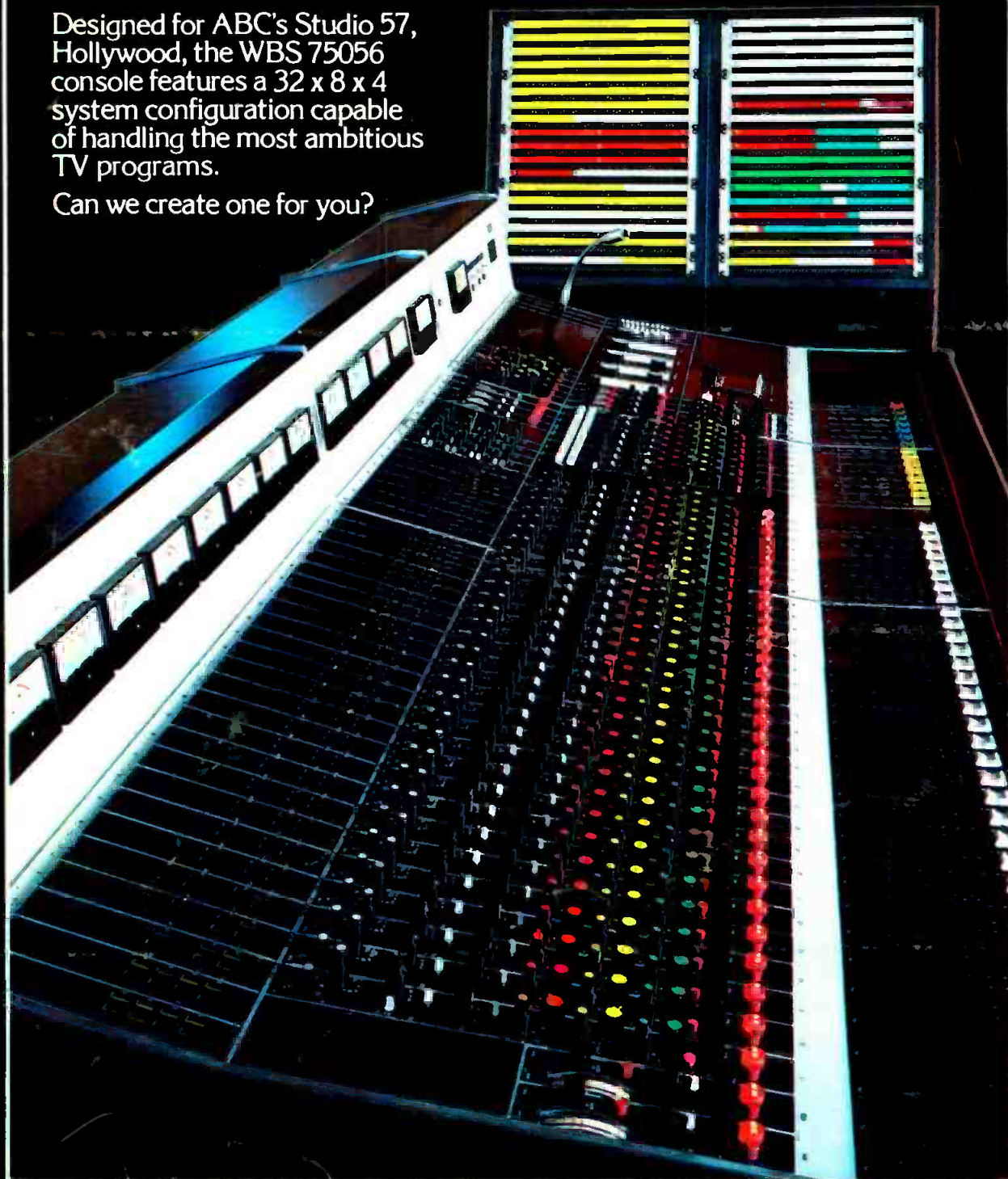

WBS

Tomorrow's Technology Today.

Ward-Beck Systems Ltd., 841 Progress Avenue, Scarborough, Ontario M1H 2X4.
Telephone (416) 438-6550. Telex 06-23469.

Ward-Beck Systems Inc., 290 Larkin Street, Buffalo, N.Y. 14210.

Circle 156 on Reader Service Card